

# ALLIED'S ELECTRONICS DATA HANDBOOK

*George V. Hahn*

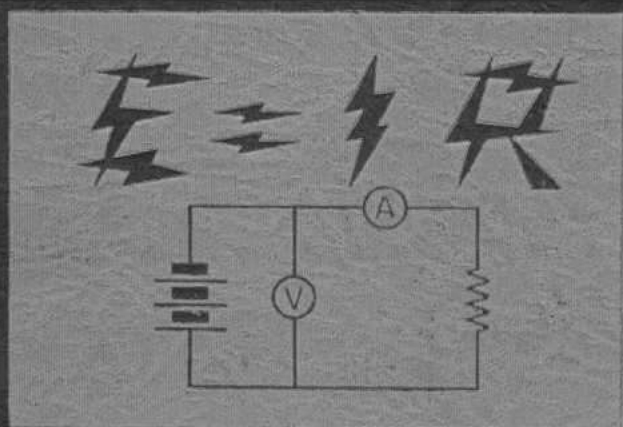

**ALLIED RADIO CORPORATION**  
CHICAGO

# ALLIED'S ELECTRONICS DATA HANDBOOK

Formerly Allied's Radio Data Handbook

A Compilation of Formulas and Data Most Commonly Used in the Field of Radio and Electronics

*Written and Compiled by the  
Publications Division*  
ALLIED RADIO CORPORATION  
*Under the Direction of*  
EUGENE CARRINGTON

*Edited by*  
NELSON M. COOKE,  
*Lieutenant Commander, United States Navy (Ret.)*  
Senior Member, Institute of Radio Engineers Author, "Mathematics for  
Electricians and Radiomen".

SECOND EDITION  
5th Printing, October, 1957

*Published by*  
ALLIED RADIO CORPORATION  
100 North Western Avenue  
Chicago 80, Ill., U. S. A.

## FOREWORD

---

*Allied Radio Corporation* has long recognized the need for a comprehensive and condensed handbook of formulas and data most commonly used in the field of radio and electronics. It was felt also that such a book should serve entirely as a convenient source of information and reference and that all attempts to teach or explain the basic principles involved should be left to classroom instruction and to the many already existing publications written for this distinct purpose.

The *Electronics Data Handbook*, therefore, consists of formulas, tables, charts and data. Every effort has been made to present this information clearly and to arrange it in a convenient manner for instant reference. All material was carefully selected and prepared by *Allied's* technical staff to serve the requirements of many specific groups in the radio and electronics field. It is hoped that our objectives have been successfully attained and that this *Handbook* will serve as: (1) A valuable adjunct to classroom study and laboratory work for the student and instructor; (2) A dependable source of information for the beginner, experimenter and set builder; (3) A reliable guide for the service engineer and maintenance man in his everyday work; (4) A time-saving and practical reference for the radio amateur, technician and engineer, both in the laboratory and in the field of operations.

The publishers are indebted to the McGraw-Hill Book Company, Inc., for their permission to use material selected from "*Mathematics for Electricians and Radiomen*" by Nelson M. Cooke. *Allied* also takes this opportunity to thank those manufacturers who so generously permitted our use of current data prepared by their engineering personnel. Special recognition and our sincere appreciation are extended to Commander Cooke for his helpful suggestions and generous contribution of his time and specialized knowledge in editing the material contained in this book.

ALLIED RADIO CORPORATION

## TABLE OF CONTENTS

<b>Fundamental Mathematical Data</b>	4-5
Mathematical Constants	4
Mathematical Symbols	4
Decimal Parts of an Inch	4
Fundamental Algebraic Formulas	5
<b>Decibel Tables, Attenuators and Matching Pads</b>	5-10
Decibels, Fundamental Formulas	5
dB Expressed in Watts and Volts	5
Decibel-Voltage, Current and Power Ratio Table	6
Table of Values for Attenuator Network Formulas	7-8
Attenuator Network Formulas	8-9
Minimum Loss Pads	10
<b>Most Used Radio and Electronic Formulas</b>	11-25
70-Volt Loud-Speaker Matching Formulas	11
Resistance	12
Capacitance	12
Inductance	12-13
Reactance	13
Resonance	13
Frequency and Wavelength	13
"Q" Factor	14
Impedance	14-16
Conductance	17
Susceptance	17
Admittance	17
Transient <i>I</i> and <i>E</i> in <i>LCR</i> Circuits	18-19
Steady State Current Flow	19
Transmission Line Formulas	20
Capacity of a Vertical Antenna	20
Vacuum Tube Formulas and Symbols	21
R.M.S., Peak and Average Volts and Current	21
D-C Meter Formulas	22-23
Ohm's Law for A-C and D-C Circuits	24-25
<b>Engineering and Servicing Data</b>	26-55
R-F Coil Winding Formulas	26
Wire Table	27
R-F Coil Winding Data Chart	28
Inductance, Capacitance, Reactance Charts	29-32
How to Use Logarithms	33-35
Trigonometric Relationships	36
Metric Relationships	37
Pilot Lamp Data	38
Directly Interchangeable Tubes	39-42
Directly Interchangeable TV Picture Tubes	43-44
Interchangeable Batteries	45-46
RETMA and Military Color Codes for Resistors and Capacitors	47-50
RETMA Color Codes for Chassis Wiring	51-53
Schematic Symbols used in Radio Diagrams	54
Abbreviations and Letter Symbols	55
<b>Log and Trig Tables</b>	56-63
Four-Place Common Log Tables	56-57
Table of Natural Sines, Cosines and Tangents	58-63
<b>Index</b>	64

**Mathematical Symbols**

- × or · Multiplied by
- ÷ or : Divided by
- + Positive, Plus, Add
- Negative, Minus, Subtract
- ± Positive or negative, Plus or minus
- ±± Negative or positive, Minus or plus
- = or :: Equals
- ≡ Identity
- ≈ Is approximately equal to
- ≠ Does not equal
- > Is greater than
- ≫ Is much greater than
- < Is less than
- ≪ Is much less than
- ≥ Greater than or equal to
- ≤ Less than or equal to
- ∴ Therefore
- ∠ Angle
- Δ Increment or Decrement
- ⊥ Perpendicular to
- ∥ Parallel to
- |n| Absolute value of n

**Mathematical Constants**

- $\pi = 3.14$
- $2\pi = 6.28$
- $(2\pi)^2 = 39.5$
- $4\pi = 12.6$
- $\pi^2 = 9.87$
- $\frac{\pi}{2} = 1.57$
- $\frac{1}{\pi} = 0.318$
- $\frac{1}{2\pi} = 0.159$
- $\frac{1}{\pi^2} = 0.101$
- $\frac{1}{\sqrt{\pi}} = 0.564$
- $\sqrt{\pi} = 1.77$
- $\sqrt{\frac{\pi}{2}} = 1.25$
- $\sqrt{2} = 1.41$
- $\sqrt{3} = 1.73$
- $\frac{1}{\sqrt{2}} = 0.707$
- $\frac{1}{\sqrt{3}} = 0.577$
- $\log \pi = 0.497$
- $\log \frac{\pi}{2} = 0.196$
- $\log \pi^2 = 0.994$
- $\log \sqrt{\pi} = 0.248$

**Decimal Inches**

- Inches × 2.540 = Centimeters
- Inches × 1.578 × 10<sup>5</sup> = Miles
- Inches × 10<sup>3</sup> = Mils

Inches		Decimal Equivalent	Millimeter Equivalent
1/64	1/32	.0156 .0313	0.397 0.794
3/64	1/16	.0469 0.0938	1.191 1.588
5/64	3/32	.0781 0.1563	1.985 2.381
7/64	1/8	.1094 0.2188	2.778 3.175
9/64	5/32	.1406 0.2813	3.572 3.969
11/64	3/16	.1719 0.3438	4.366 4.762
13/64	7/32	.2031 0.4063	5.159 5.556
15/64	1/4	.2344 0.4688	5.953 6.350
17/64	9/32	.2656 0.5313	6.747 7.144
19/64	5/16	.2969 0.5938	7.541 7.937
21/64	11/32	.3281 0.6563	8.334 8.731
23/64	3/8	.3594 0.7188	9.128 9.525
25/64	13/32	.3906 0.7813	9.922 10.319
27/64	7/16	.4219 0.8438	10.716 11.112
29/64	15/32	.4531 0.9063	11.509 11.906
31/64	1/2	.4844 0.9688	12.303 12.700
33/64	17/32	.5156 1.0313	13.097 13.494
35/64	9/16	.5469 1.0938	13.891 14.287
37/64	19/32	.5781 1.1563	14.684 15.081
39/64	5/8	.6094 1.2188	15.478 15.875
41/64	21/32	.6406 1.2813	16.272 16.669
43/64	11/16	.6719 1.3438	17.067 17.463
45/64	23/32	.7031 1.4063	17.860 18.256
47/64	3/4	.7344 1.4688	18.653 19.049
49/64	25/32	.7656 1.5313	19.446 19.842
51/64	13/16	.7969 1.5938	20.239 20.636
53/64	27/32	.8281 1.6563	21.033 21.430
55/64	7/8	.8594 1.7188	21.827 22.224
57/64	29/32	.8906 1.7813	22.621 23.018
59/64	15/16	.9219 1.8438	23.415 23.812
61/64	31/32	.9531 1.9063	24.209 24.606
63/64	1.0	.9844 1.0000	25.004 25.400

## Algebra

### Exponents and Radicals

$$a^x \times a^y = a^{(x+y)}, \quad \frac{a^x}{a^y} = a^{(x-y)},$$

$$(ab)^x = a^x b^x, \quad \left(\frac{a}{b}\right)^x = \frac{a^x}{b^x},$$

$$\sqrt[x]{\frac{a}{b}} = \frac{\sqrt[x]{a}}{\sqrt[x]{b}}, \quad a^{-x} = \frac{1}{a^x}$$

$$(a^x)^y = a^{xy}, \quad \sqrt[x]{\sqrt[y]{a}} = \sqrt[xy]{a},$$

$$\sqrt[x]{ab} = \sqrt[x]{a} \sqrt[x]{b}, \quad a^{\frac{1}{b}} = \sqrt[b]{a^1},$$

$$a^x = \sqrt[x]{a^x}, \quad a^0 = 1.$$

### Solution of a Quadratic

Quadratic equations in the form

$$ax^2 + bx + c = 0$$

may be solved by the following:

$$x = \frac{-b \pm \sqrt{b^2 - 4ac}}{2a}$$

### Transposition of Terms

If  $A = \frac{B}{C}$ , then  $B = AC$ ,  $C = \frac{B}{A}$ .

If  $\frac{A}{B} = \frac{C}{D}$ , then  $A = \frac{BC}{D}$ ,

$$B = \frac{AD}{C}, \quad C = \frac{AD}{B}, \quad D = \frac{BC}{A}$$

If  $A = \frac{1}{D\sqrt{BC}}$ , then  $A^2 = \frac{1}{D^2BC}$ .

$$B = \frac{1}{D^2 A^2 C}, \quad C = \frac{1}{D^2 A^2 B}, \quad D = \frac{1}{A\sqrt{BC}}$$

If  $A = \sqrt{B^2 + C^2}$ , then  $A^2 = B^2 + C^2$ ,

$$B = \sqrt{A^2 - C^2}, \quad C = \sqrt{A^2 - B^2}.$$

## Decibels

The number of db by which two power outputs  $P_1$  and  $P_2$  (in watts) may differ, is expressed by

$$10 \log \frac{P_1}{P_2};$$

or in terms of volts,

$$20 \log \frac{E_1}{E_2};$$

or in current,

$$20 \log \frac{I_1}{I_2}.$$

While power ratios are independent of source and load impedance values, voltage and current ratios in these formulas hold true only when the source and load impedances  $Z_1$  and  $Z_2$  are equal. In circuits where these impedances differ, voltage and current ratios are expressed by,

$$db = 20 \log \frac{E_1 \sqrt{Z_2}}{E_2 \sqrt{Z_1}} \quad \text{or,} \quad 20 \log \frac{I_1 \sqrt{Z_1}}{I_2 \sqrt{Z_2}}$$

### DB Expressed in Watts & Volts

DB	Above Zero Level		Below Zero Level	
	Watts	Volts	Watts	Volts
0	0.00500	1.73	6.00x10 <sup>-3</sup>	1.73
1	0.00755	1.94	4.77x10 <sup>-3</sup>	1.54
2	0.00951	2.18	3.78x10 <sup>-3</sup>	1.38
3	0.0120	2.45	3.01x10 <sup>-3</sup>	1.23
4	0.0151	2.74	2.39x10 <sup>-3</sup>	1.09
5	0.0190	3.08	1.90x10 <sup>-3</sup>	0.974
6	0.0239	3.46	1.51x10 <sup>-3</sup>	0.868
7	0.0301	3.88	1.20x10 <sup>-3</sup>	0.774
8	0.0378	4.35	9.51x10 <sup>-4</sup>	0.690
9	0.0477	4.88	7.55x10 <sup>-4</sup>	0.614
10	0.0600	5.48	6.00x10 <sup>-4</sup>	0.548
11	0.0755	6.14	4.77x10 <sup>-4</sup>	0.488
12	0.0951	6.90	3.78x10 <sup>-4</sup>	0.435
13	0.120	7.74	3.01x10 <sup>-4</sup>	0.388
14	0.151	8.68	2.39x10 <sup>-4</sup>	0.346
15	0.190	9.74	1.90x10 <sup>-4</sup>	0.308
16	0.239	10.93	1.51x10 <sup>-4</sup>	0.275
17	0.301	12.26	1.20x10 <sup>-4</sup>	0.245
18	0.378	13.76	9.51x10 <sup>-5</sup>	0.218
19	0.477	15.44	7.55x10 <sup>-5</sup>	0.191
20	0.600	17.32	6.00x10 <sup>-5</sup>	0.173
25	1.90	30.8	1.90x10 <sup>-6</sup>	0.0974
30	6.00	54.8	6.00x10 <sup>-7</sup>	0.0548
35	19.0	97.4	1.90x10 <sup>-8</sup>	0.0308
40	60.0	173	6.00x10 <sup>-9</sup>	0.0173
45	190	308	1.90x10 <sup>-10</sup>	0.00974
50	600	548	6.00x10 <sup>-11</sup>	0.00548
60	6,000	1,730	6.00x10 <sup>-13</sup>	0.00173
70	60,000	5,480	6.00x10 <sup>-15</sup>	0.000548
80	600,000	17,300	6.00x10 <sup>-17</sup>	0.000173

\*Zero db = 6 milliwatts into a 500 ohm load. Power ratios hold for any impedance, but voltages must be referred to an impedance load of 500 ohms.

Decibel—Voltage, Current and Power Ratio Table

-		DB	+		-		DB	+	
Voltage or Current Ratio	Power Ratio		Voltage or Current Ratio	Power Ratio	Voltage or Current Ratio	Power Ratio		Voltage or Current Ratio	Power Ratio
1.0000	1.0000	0	1.000	1.000	.4898	.2399	6.2	2.042	4.169
.9886	.9772	.1	1.012	1.023	.4842	.2344	6.3	2.065	4.266
.9772	.9550	.2	1.023	1.047	.4786	.2291	6.4	2.089	4.365
.9661	.9333	.3	1.035	1.072	.4732	.2239	6.5	2.113	4.467
.9550	.9120	.4	1.047	1.096	.4677	.2188	6.6	2.138	4.571
.9441	.8913	.5	1.059	1.122	.4624	.2138	6.7	2.163	4.677
.9333	.8710	.6	1.072	1.148	.4571	.2089	6.8	2.188	4.786
.9226	.8511	.7	1.084	1.175	.4519	.2042	6.9	2.213	4.898
.9120	.8318	.8	1.096	1.202	.4467	.1995	7.0	2.239	5.012
.9016	.8128	.9	1.109	1.230	.4416	.1950	7.1	2.265	5.129
.8913	.7943	1.0	1.122	1.259	.4365	.1905	7.2	2.291	5.248
.8810	.7762	1.1	1.135	1.288	.4315	.1862	7.3	2.317	5.370
.8710	.7586	1.2	1.148	1.318	.4266	.1820	7.4	2.344	5.495
.8610	.7413	1.3	1.161	1.349	.4217	.1778	7.5	2.371	5.623
.8511	.7244	1.4	1.175	1.380	.4169	.1738	7.6	2.399	5.754
.8414	.7079	1.5	1.189	1.413	.4121	.1698	7.7	2.427	5.888
.8318	.6918	1.6	1.202	1.445	.4074	.1660	7.8	2.455	6.026
.8222	.6761	1.7	1.216	1.479	.4027	.1622	7.9	2.483	6.166
.8128	.6607	1.8	1.230	1.514	.3981	.1585	8.0	2.512	6.310
.8035	.6457	1.9	1.245	1.549	.3936	.1549	8.1	2.541	6.457
.7943	.6310	2.0	1.259	1.585	.3890	.1514	8.2	2.570	6.607
.7852	.6166	2.1	1.274	1.622	.3846	.1479	8.3	2.600	6.761
.7762	.6026	2.2	1.288	1.660	.3802	.1445	8.4	2.630	6.918
.7674	.5888	2.3	1.303	1.698	.3758	.1413	8.5	2.661	7.079
.7586	.5754	2.4	1.318	1.738	.3715	.1380	8.6	2.692	7.244
.7499	.5623	2.5	1.334	1.778	.3673	.1349	8.7	2.723	7.413
.7413	.5495	2.6	1.349	1.820	.3631	.1318	8.8	2.754	7.586
.7328	.5370	2.7	1.365	1.862	.3589	.1288	8.9	2.786	7.762
.7244	.5248	2.8	1.380	1.905	.3548	.1259	9.0	2.818	7.943
.7161	.5129	2.9	1.396	1.950	.3508	.1230	9.1	2.851	8.128
.7079	.5012	3.0	1.413	1.995	.3467	.1202	9.2	2.884	8.318
.6998	.4898	3.1	1.429	2.042	.3428	.1175	9.3	2.917	8.511
.6918	.4786	3.2	1.445	2.089	.3388	.1148	9.4	2.951	8.710
.6839	.4677	3.3	1.462	2.138	.3350	.1122	9.5	2.985	8.913
.6761	.4571	3.4	1.479	2.188	.3311	.1096	9.6	3.020	9.120
.6683	.4467	3.5	1.496	2.239	.3273	.1072	9.7	3.055	9.333
.6607	.4365	3.6	1.514	2.291	.3236	.1047	9.8	3.090	9.550
.6531	.4266	3.7	1.531	2.344	.3199	.1023	9.9	3.126	9.772
.6457	.4169	3.8	1.549	2.399	.3162	.1000	10.0	3.162	10.000
.6383	.4074	3.9	1.567	2.455	.2985	.08913	10.5	3.350	11.22
.6310	.3981	4.0	1.585	2.512	.2818	.07943	11.0	3.548	12.59
.6237	.3890	4.1	1.603	2.570	.2661	.07079	11.5	3.758	14.13
.6166	.3802	4.2	1.622	2.630	.2512	.06310	12.0	3.981	15.85
.6095	.3715	4.3	1.641	2.692	.2371	.05623	12.5	4.217	17.78
.6026	.3631	4.4	1.660	2.754	.2239	.05012	13.0	4.467	19.95
.5957	.3548	4.5	1.679	2.818	.2113	.04467	13.5	4.732	22.39
.5888	.3467	4.6	1.698	2.884	.1995	.03981	14.0	5.012	25.12
.5821	.3388	4.7	1.718	2.951	.1884	.03548	14.5	5.309	28.18
.5754	.3311	4.8	1.738	3.020	.1778	.03162	15.0	5.623	31.62
.5689	.3236	4.9	1.758	3.090	.1585	.02512	16.0	6.310	39.81
.5623	.3162	5.0	1.778	3.162	.1413	.01995	17.0	7.079	50.12
.5559	.3090	5.1	1.799	3.236	.1259	.01585	18.0	7.943	63.10
.5495	.3020	5.2	1.820	3.311	.1122	.01259	19.0	8.913	79.43
.5433	.2951	5.3	1.841	3.388	.1000	.01000	20.0	10.000	100.00
.5370	.2884	5.4	1.862	3.467	.03162	.00100	30.0	31.620	1,000.00
.5309	.2818	5.5	1.884	3.548	.01	.00010	40.0	100.00	10,000.00
.5248	.2754	5.6	1.905	3.631	.003162	.00001	50.0	316.20	10 <sup>5</sup>
.5188	.2692	5.7	1.928	3.715	.001	10 <sup>-4</sup>	60.0	1,000.00	10 <sup>6</sup>
.5129	.2630	5.8	1.950	3.802	.0003162	10 <sup>-7</sup>	70.0	3,162.00	10 <sup>7</sup>
.5070	.2570	5.9	1.972	3.890	.0001	10 <sup>-1</sup>	80.0	10,000.00	10 <sup>8</sup>
.5012	.2512	6.0	1.995	3.931	.00003162	10 <sup>-9</sup>	90.0	31,620.00	10 <sup>9</sup>
.4955	.2455	6.1	2.018	4.074	10 <sup>-5</sup>	10 <sup>-10</sup>	100.0	10 <sup>2</sup>	10 <sup>10</sup>

# Table of Values for Attenuator Network Formulas

db	A	B	C	D	E	db	A	B	C	D	E
-1	98855	011447	86.360	.005756	86.857	<b>27.0</b>	.044668	.95533	.046757	.91448	.089515
-2	97724	022763	42.931	.011512	43.426	<b>27.5</b>	.042170	.95783	.044026	.91907	.084490
.25	97163	028372	34.247	.014390	34.739	<b>28.0</b>	.039811	.96019	.041461	.92343	.079748
.3	96605	.034046	28.456	.017268	28.947	<b>30.0</b>	.031623	.96838	.032655	.93869	.063309
.4	95499	.045008	21.219	.023022	21.707	<b>32.0</b>	.025119	.97488	.025766	.95069	.050269
.5	94406	.055939	16.876	.028774	17.362	<b>32.5</b>	.023114	.97629	.024290	.94754	.047454
.6	93325	.066745	13.982	.034525	14.428	<b>33.0</b>	.022287	.97761	.022900	.94621	.046797
.7	92257	.077429	11.915	.040274	12.395	<b>34.0</b>	.019953	.98005	.020359	.94688	.039921
.75	91728	.082724	11.088	.043147	11.567	<b>35.0</b>	.017783	.98222	.018105	.96506	.035577
.8	91201	.087989	10.365	.046019	10.842		.015949	.98415	.016104	.96880	.031706
.9	90157	.098429	9.1596	.051762	9.6337	<b>37.5</b>	.013335	.98666	.013515	.97368	.026675
1.0	89125	.10875	8.1955	.057501	8.6667	<b>38.0</b>	.012589	.98741	.012750	.97513	.025183
1.5	84140	.15860	5.3050	.086133	5.7619	<b>39.0</b>	.011220	.98878	.011348	.97781	.022443
2.0	79433	.20567	3.8621	.11462	4.3048	<b>40.0</b>	.010000	.99000	.010101	.98020	.020002
2.5	74989	.25011	2.9863	.14293	3.4268	<b>42.0</b>	.0079433	.99206	.0080069	.98424	.015888
3.0	70795	.29205	2.4240	.17100	2.8385	<b>42.5</b>	.0074989	.99250	.0075556	.98511	.014999
3.5	66834	.33166	2.0152	.19879	2.4158	<b>44.0</b>	.0063096	.99369	.0063496	.98746	.012620
4.0	63096	.36904	1.7097	.22627	2.0966	<b>45.0</b>	.0056234	.99438	.0056552	.98882	.011247
4.5	59566	.40434	1.4732	.25340	1.8465	<b>45.5</b>	.0042170	.99578	.0042348	.99160	.0084341
5.0	56234	.43766	1.2849	.28013	1.6448	<b>48.0</b>	.0039811	.99602	.0039970	.99207	.0079623
6.0	50119	.49881	1.0048	.33228	1.3386	<b>50.0</b>	.0031623	.99684	.0031723	.99370	.0065246
7.0	44668	.55332	.80728	.38247	1.1160	<b>51.0</b>	.0028184	.99718	.0028264	.99438	.0056368
7.5	42170	.57830	.72920	.40677	1.0258	<b>52.0</b>	.0025119	.99749	.0025182	.99499	.0050238
8.0	39811	.60189	.66143	.43051	94617	<b>54.0</b>	.0019953	.99800	.0019993	.99502	.0039905
9.0	35481	.64519	.54994	.47622	81183	<b>55.0</b>	.0017883	.99822	.0017815	.99545	.0035566
10.0	31623	.68377	.46248	.51949	.70273	<b>56.0</b>	.0015849	.99842	.0015874	.99584	.0031698
11.0	28184	.71816	.39244	.56026	.61231	<b>57.0</b>	.0014145	.99859	.0014145	.99718	.0028291
12.0	25119	.74891	.33545	.59848	.53521	<b>60.0</b>	.0010000	.99900	.00100100	.99800	.0020000
12.5	23174	.76286	31085	.61664	.50253	<b>64.0</b>	.00063096	.99937	.00063136	.99874	.0012619
13.0	22387	.77613	28845	.63416	.47137	<b>65.0</b>	.00056234	.99944	.00056266	.99888	.0011247
14.0	19953	.80047	24926	.66732	.44150	<b>66.0</b>	.00050119	.99950	.00050144	.99900	.0010024
15.0	17783	.82217	.21629	.69804	.36727	<b>68.0</b>	.00039811	.99960	.00039827	.99920	.0007962
16.0	15849	.84131	.18834	.72639	.32515	<b>70.0</b>	.00031623	.99968	.00031633	.99937	.0006325
17.0	14125	.85875	.16449	.75246	.28826	<b>72.0</b>	.00025119	.99975	.00025125	.99950	.0005024
17.5	13335	.86665	.15387	.76468	.27153	<b>75.0</b>	.00017783	.99982	.00017786	.99968	.0003557
18.0	12589	.87411	.14402	.77637	.25584	<b>76.0</b>	.00015849	.99984	.00015851	.99968	.0003170
19.0	11220	.88780	.12638	.79823	.22726	<b>78.0</b>	.00012589	.99987	.00012591	.99975	.0002518
20.0	100000	.90000	.111111	.81818	.20202	<b>80.0</b>	.00010000	.99990	.00010000	.99980	.0002000
21.0	889125	.91087	.097846	.83634	.17968	<b>84.0</b>	.00006310	.99994	.00006310	.99980	.0001262
22.0	079439	.92057	.086287	.85282	.15987	<b>85.0</b>	.00005623	.99994	.00005624	.99989	.0001125
22.5	074989	.92501	.081069	.86048	.15083	<b>90.0</b>	.00003162	.99997	.00003162	.99994	.00006325
24.0	063096	.93690	.067345	.88130	.12670	<b>95.0</b>	.00001778	.99998	.00001778	.99996	.00003557
25.0	056234	.94377	.059585	.89352	.11283	<b>96.0</b>	.00001585	.99998	.00001585	.99997	.00003170
26.0	050119	.94988	.052763	.90455	.10049	<b>100.0</b>	.00001000	.99999	.00001000	.99998	.00002000



# Attenuator Networks

## For Insertion Between Equal Impedances

For data covering networks between unequal impedances, see Minimum Loss Pads on page 10. See also Decibel—Voltage Current and Power Ratio Table on page 6.

See table on page 7 for values of A, B, C, D, E used in the following attenuator network formulas.

In the case of L and U networks where only the input or output can be matched, as required, the matched side is indicated by an arrow pointing toward the pad. On all other networks, both the input and output circuits are matched.

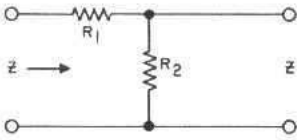
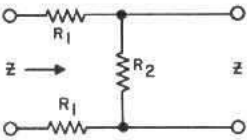
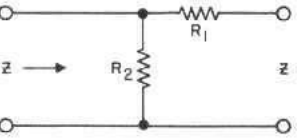
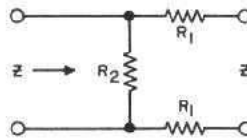
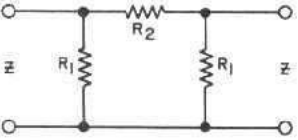
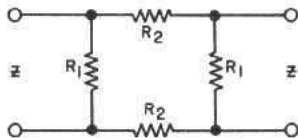
 <p style="text-align: center;"><math>R_1 = ZB</math> <math>R_2 = ZC</math></p> <p>L</p>	 <p style="text-align: center;"><math>R_1 = \frac{ZB}{2}</math> <math>R_2 = ZC</math></p> <p>U</p>
 <p style="text-align: center;"><math>R_1 = \frac{Z}{C}</math> <math>R_2 = \frac{Z}{B}</math></p> <p>L</p>	 <p style="text-align: center;"><math>R_1 = \frac{Z}{2C}</math> <math>R_2 = \frac{Z}{B}</math></p> <p>U</p>
 <p style="text-align: center;"><math>R_1 = \frac{Z}{D}</math> <math>R_2 = \frac{Z}{E}</math></p> <p><math>\pi</math></p>	 <p style="text-align: center;"><math>R_1 = \frac{Z}{D}</math> <math>R_2 = \frac{Z}{2E}</math></p> <p>O</p>

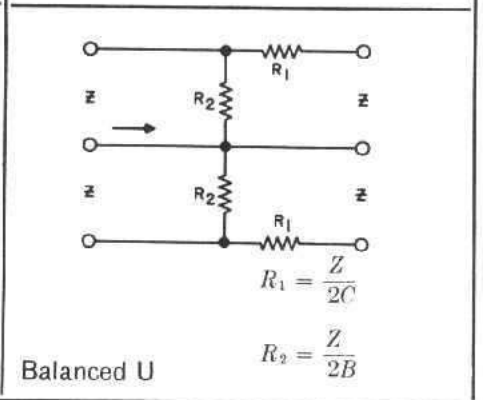
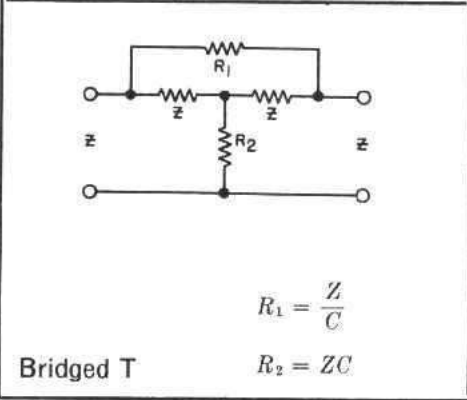
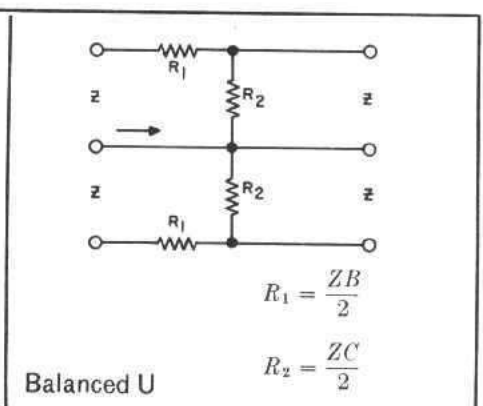
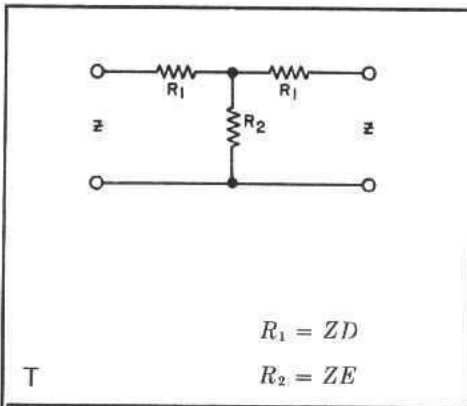

### Constant Impedance Attenuators in Parallel

Table of  $R_1$  Values in Ohms

Z	Number of Channels				
	2	3	4	5	6
30	10	15	18	20	21.5
50	16.6	25	30	33.3	35.7
150	50	75	90	100	107
200	66.6	100	120	133	143
250	83.3	125	150	166	179
500	166	250	300	333	357
600	200	300	360	400	428
Network db Loss	6	9.5	12	14	15.5

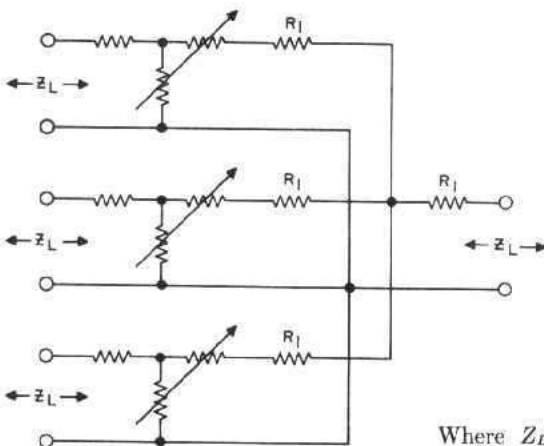

$$R_1 = Z_L \left( \frac{N-1}{N+1} \right) \quad \left| \quad \begin{array}{l} \text{Insertion loss} \\ \text{in db} = 20 \log_{10} N \end{array} \right.$$

Where  $Z_L$  = identical line and load impedances;  
and  $N$  = number of channels in parallel.

## Minimum Loss Pads

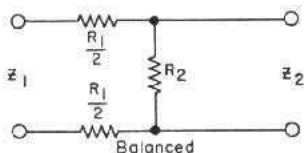
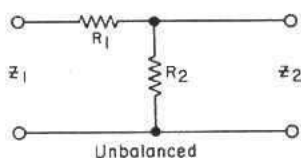

**For Matching Two Impedances where  $Z_1 > Z_2$**

$$R_1 = \sqrt{Z_1 (Z_1 - Z_2)}$$

$$R_2 = \frac{Z_1 Z_2}{R_1}$$

$$db \text{ loss} = 20 \log_{10} \left( \sqrt{\frac{Z_1}{Z_2}} + \sqrt{\frac{Z_1}{Z_2} - 1} \right)$$

**Where Only One Impedance is to be Matched**

If the larger impedance only is to be

matched, use a resistor  $R_L$  in series with the smaller impedance such that

$$R_L = Z_1 - Z_2$$

$$db \text{ loss} = 20 \log_{10} \sqrt{\frac{Z_1}{Z_2}}$$

If the smaller impedance only is to be matched, use a resistor  $R_S$  in shunt across the larger impedance such that

$$R_S = \frac{Z_1 Z_2}{Z_1 - Z_2}$$

Here also  $db \text{ loss} = 20 \log_{10} \sqrt{\frac{Z_1}{Z_2}}$

## Tables of $R_1$ and $R_2$ Values

When  $Z_1$  is 500 ohms  
and  $Z_2$  is less than 500 ohms.

$Z_2$	400	300	250	200	160	125	100	80	65	50	40	30	25
$R_1$	224	316	354	387	412	433	447	458	466	474	480	485	487
$R_2$	894	474	354	258	194	144	112	87.3	69.7	52.7	41.7	30.9	25.6
<b>db loss</b>	4	6.5	7.5	9	10	11.5	12.5	13.5	14.5	16	17	18	19

When  $Z_2$  is less than 25 ohms,

$$\text{let } R_1 = 500 - \frac{Z_1}{Z_2}$$

$$\text{and } R_2 = Z_2$$

Where  $Z_2$  is 500 ohms,  
and  $Z_1$  is greater than 500 ohms.

$Z_1$	600	800	1,000	1,200	1,500	2,000	2,500	3,000	4,000	5,000	6,000	8,000	10,000
$R_1$	245	490	707	917	1,225	1,732	2,236	2,739	3,742	4,743	5,745	7,746	9,747
$R_2$	1,225	817	707	655	612	577	559	548	534	527	522	516	513
<b>db Loss</b>	3.5	6	7.5	9	10	11.5	12.5	13.5	15	16	17	18	19

When  $Z_1$  is greater than 10,000 ohms,

$$\text{let } R_1 = Z_1 - 250$$

$$\text{and } R_2 = 500$$

## 70-Volt Loud-Speaker Matching Systems

The RETMA 70.7 volt constant voltage system of power distribution provides the engineer and technician with a simple means of matching a number of loudspeakers to an amplifier. To use this method:

1. Determine the power required at each loudspeaker.
2. Add the powers required for the individual speakers and select an amplifier with a rated power output equal to or greater than this total.
3. Select 70.7-volt transformers having primary wattage taps as determined in step 1.\*
4. Wire the selected primaries in parallel across the 70.7-volt line.
5. Connect each secondary to its speaker; selecting the tap which matches the voice coil impedance.

For transformers rated in impedance, the following formulas may be used to determine the proper taps in step 3.

$$\frac{\text{Primary Impedance}}{\text{Desired speaker power}} = \frac{(\text{Amplifier output voltage})^2}{\text{Desired speaker power}}$$

or 
$$Z = \frac{E^2}{P} \quad (1)$$

\*These transformers have the primary taps marked in watts and the secondaries marked in ohms.

Since the voltage at rated amplifier power is 70.7, this reduces to:

$$Z = \frac{70.7^2}{P} = \frac{5000}{P} \quad (2)$$

From formula (2) these relationships are:

- 1 watt requires 5000 ohm primary
- 2 watts requires 2500 ohm primary
- 5 watts requires 1000 ohm primary
- 10 watts requires 500 ohm primary

Once the primary taps have been determined, continue on through step 4 and 5 as outlined above. When selecting transformer primary taps, use the next highest available value above the computed value. A mismatch of 25% is generally considered permissible.

### Example: Required

One 6 watt speaker with 4 ohm voice coil.  
Two 10 watt speakers with 8 ohm voice coils (use one transformer at this location).

(1-2) Total power = 6 + 10 + 10 = 26 watts (use a 30-watt amplifier or other amplifier capable of handling at least 26 watts)

(3)  $Z_{6 \text{ watts}} = \frac{5000}{6} = 833 \text{ ohms}$  (use 1000 ohm transformer)

$Z_{20 \text{ watts}} = \frac{5000}{20} = 250 \text{ ohms}$

(4-5) See sketch below.

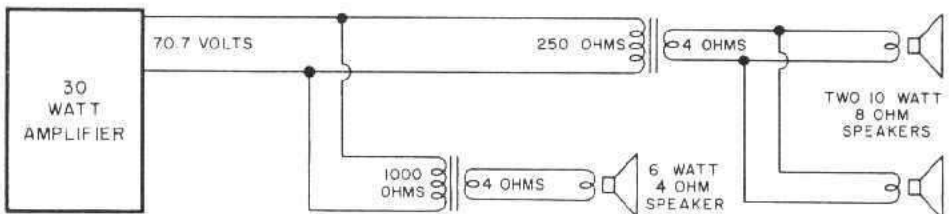

## Most Used Formulas

### Resistance Formulas

In series  $R_t = R_1 + R_2 + R_3 \dots$  etc.

In parallel  $R_t = \frac{1}{\frac{1}{R_1} + \frac{1}{R_2} + \frac{1}{R_3} \dots}$  etc.

Two resistors in parallel  $R_t = \frac{R_1 R_2}{R_1 + R_2}$

### Capacitance

In parallel  $C_t = C_1 + C_2 + C_3 \dots$  etc.

In series  $C_t = \frac{1}{\frac{1}{C_1} + \frac{1}{C_2} + \frac{1}{C_3} \dots}$  etc.

Two capacitors in series  $C_t = \frac{C_1 C_2}{C_1 + C_2}$

### The Quantity of Electricity Stored Within a Capacitor is Given by

$$Q = CE$$

where  $Q$  = the quantity stored, in coulombs,

$E$  = the potential impressed across the condenser, in volts,

$C$  = capacitance in farads.

### The Capacitance of a Parallel Plate Capacitor is Given by

$$C = 0.0885 \frac{KS(N-1)}{d}$$

where  $C$  = capacitance in mmfd.,

$K$  = dielectric constant,

\* $S$  = area of one plate in square centimeters,

$N$  = number of plates,

\* $d$  = thickness of the dielectric in centimeters (same as the distance between plates).

\* When  $S$  and  $d$  are given in inches, change constant 0.0885 to 0.224. Answer will still be in micromicrofarads.

### DIELECTRIC CONSTANTS

Kind of Dielectric	Approximate* K Value
Air (at atmospheric pressure).....	1.0
Bakelite.....	5.0
Beeswax.....	3.0
Cambric (varnished).....	4.0
Fibre (Red).....	5.0
Glass (window or flint).....	8.0
Gutta Percha.....	4.0
Mica.....	6.0
Paraffin (solid).....	2.5
Paraffin Coated Paper.....	3.5
Porcelain.....	6.0
Pyrex.....	4.5
Quartz.....	5.0
Rubber.....	3.0
Slate.....	7.0
Wood (very dry).....	5.0

\* These values are approximate, since true values depend upon quality or grade of material used, as well as moisture content, temperature and frequency characteristics of each.

### Self-Inductance

In series  $L_t = L_1 + L_2 + L_3 \dots$  etc.

In parallel  $L_t = \frac{1}{\frac{1}{L_1} + \frac{1}{L_2} + \frac{1}{L_3} \dots}$  etc.

Two inductors in parallel  $L_t = \frac{L_1 L_2}{L_1 + L_2}$

### Coupled Inductance

In series with fields *aiding*

$$L_t = L_1 + L_2 + 2M$$

In series with fields *opposing*

$$L_t = L_1 + L_2 - 2M$$

In parallel with fields *aiding*

$$L_t = \frac{1}{\frac{1}{L_1 + M} + \frac{1}{L_2 + M}}$$

In parallel with fields *opposing*

$$L_t = \frac{1}{\frac{1}{L_1 - M} + \frac{1}{L_2 - M}}$$

where  $L_t$  = the total inductance,  
 $M$  = the mutual inductance,  
 $L_1$  and  $L_2$  = the self inductance of the individual coils.

**Mutual Inductance**

The mutual inductance of two r-f coils with fields interacting, is given by

$$M = \frac{L_A - L_O}{4}$$

where  $M$  = mutual inductance, expressed in same units as  $L_A$  and  $L_O$ ,  
 $L_A$  = Total inductance of coils  $L_1$  and  $L_2$  with fields *aiding*,  
 $L_O$  = Total inductance of coils  $L_1$  and  $L_2$  with fields *opposing*.

**Coupling Coefficient**

When two r-f coils are inductively coupled so as to give transformer action, the coupling coefficient is expressed by

$$K = \frac{M}{\sqrt{L_1 L_2}}$$

where  $K$  = the coupling coefficient;  
 $(K \times 10^2 =$  coupling coefficient in %),

$M$  = the mutual inductance value,  
 $L_1$  and  $L_2$  = the self-inductance of the two coils respectively, both being expressed in the same units.

**Resonance**

The resonant frequency, or frequency at which inductive reactance  $X_L$  equals capacitive reactance  $X_C$ , is expressed by

$$f_r = \frac{1}{2\pi \sqrt{LC}}$$

also  $L = \frac{1}{4\pi^2 f_r^2 C}$

and  $C = \frac{1}{4\pi^2 f_r^2 L}$

where  $f_r$  = resonant frequency in cycles per second,  
 $L$  = inductance in henrys,  
 $C$  = capacitance in farads,  
 $2\pi = 6.28$   
 $4\pi^2 = 39.5$

**Reactance**

of an inductance is expressed by

$$X_L = 2\pi fL$$

of a capacitance is expressed by

$$X_C = \frac{1}{2\pi fC}$$

where  $X_L$  = inductive reactance in ohms, (known as positive reactance),  
 $X_C$  = capacitive reactance in ohms, (known as negative reactance),  
 $f$  = frequency in cycles per second,  
 $L$  = inductance in henrys,  
 $C$  = capacitance in farads,  
 $2\pi = 6.28$

**Frequency from Wavelength**

$$f = \frac{3 \times 10^5}{\lambda} \text{ (kilocycles)}$$

where  $\lambda$  = wavelength in *meters*.

$$f = \frac{3 \times 10^4}{\lambda} \text{ (megacycles)}$$

where  $\lambda$  = wavelength in *centimeters*.

**Wavelength from Frequency**

$$\lambda = \frac{3 \times 10^5}{f} \text{ (meters)}$$

where  $f$  = frequency in *kilocycles*.

$$\lambda = \frac{3 \times 10^4}{f} \text{ (centimeters)}$$

where  $f$  = frequency in *megacycles*.

**Q or Figure of Merit**

of a simple reactor

$$Q = \frac{X_L}{R_L}$$

of a single capacitor

$$Q = \frac{X_C}{R_C}$$

where  $Q$  = a ratio expressing the figure of merit,

$X_L$  = inductive reactance in ohms,

$X_C$  = capacitive reactance in ohms,

$R_L$  = resistance in ohms acting in series with inductance,

$R_C$  = resistance in ohms acting in series with capacitance,

**Impedance**

In any a-c circuit where resistance and reactance values of the  $R$ ,  $L$  and  $C$  components are given, the absolute or numerical magnitude of impedance and phase angle can be computed from the formulas which follow.

In general the basic formulas expressing total impedance are:

for series circuits,

$$Z_t = \sqrt{R_t^2 + X_t^2}$$

for parallel circuits,

$$Z_t = \frac{1}{\sqrt{G_t^2 + B_t^2}}$$

See page 17 for formulas involving impedance, conductance, susceptance and admittance.

In series circuits where phase angle and any two of the  $Z$ ,  $R$  and  $X$  components are known, the unknown component may be determined from the expressions:

$$Z = \frac{R}{\cos \theta} \qquad Z = \frac{X}{\sin \theta}$$

$$R = Z \cos \theta \qquad X = Z \sin \theta$$

where  $Z$  = magnitude of impedance in ohms,

$R$  = resistance in ohms,

$X$  = reactance (inductive or capacitive) in ohms.

**Nomenclature**

$Z$  = absolute or numerical value of impedance magnitude in ohms

$R$  = resistance in ohms,

$X_L$  = inductive reactance in ohms,

$X_C$  = capacitive reactance in ohms,

$L$  = inductance in henrys,

$C$  = capacitance in farads,

$R_L$  = resistance in ohms acting in series with inductance,

$R_C$  = resistance in ohms acting in series with capacitance,

$\theta$  = phase angle in degrees by which current leads voltage in a capacitive circuit, or lags voltage in an inductive circuit. In a resonant circuit, where  $X_L$  equals  $X_C$ ,  $\theta$  equals  $0^\circ$ .

Degrees  $\times 0.0175$  = radians.

1 radian =  $57.3^\circ$ .

**Numerical Magnitude of Impedance . . .**

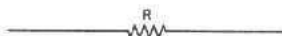

of resistance alone

$$Z = R$$

$$\theta = 0^\circ$$

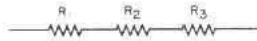

of resistance in series

$$Z = R_1 + R_2 + R_3 \dots \text{etc.}$$

$$\theta = 0^\circ$$

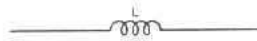

of inductance alone

$$Z = X_L$$

$$\theta = +90^\circ$$

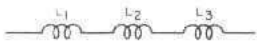

of inductance in series

$$Z = X_{L1} + X_{L2} + X_{L3} \dots \text{etc.}$$

$$\theta = +90^\circ$$



of capacitance alone

$$Z = X_C$$

$$\theta = -90^\circ$$

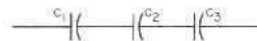

of capacitance in series

$$Z = X_{C1} + X_{C2} + X_{C3} \dots \text{etc.}$$

$$\theta = -90^\circ$$



or where only 2 capacitances  $C_1$  and  $C_2$  are involved,

$$Z = \frac{1}{2\pi f} \left( \frac{C_1 + C_2}{C_1 C_2} \right)$$

$$\theta = -90^\circ$$



of resistance and inductance in series

$$Z = \sqrt{R^2 + X_L^2}$$

$$\theta = \arctan \frac{X_L}{R}$$



of resistance and capacitance in series

$$Z = \sqrt{R^2 + X_C^2}$$

$$\theta = \arctan \frac{X_C}{R}$$



of inductance and capacitance in series

$$Z = X_L - X_C$$

$$\theta = -90^\circ \text{ when } X_L < X_C$$

$$= 0^\circ \text{ when } X_L = X_C$$

$$= +90^\circ \text{ when } X_L > X_C$$



of resistance, inductance and capacitance in series

$$Z = \sqrt{R^2 + (X_L - X_C)^2}$$

$$\theta = \arctan \frac{X_L - X_C}{R}$$

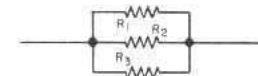

of resistance in parallel

$$Z = \frac{1}{\frac{1}{R_1} + \frac{1}{R_2} + \frac{1}{R_3} \dots \text{etc.}}$$

$$\theta = 0^\circ$$

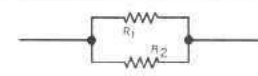

or where only 2 resistances  $R_1$  and  $R_2$  are involved,

$$Z = \frac{R_1 R_2}{R_1 + R_2}$$

$$\theta = 0^\circ$$

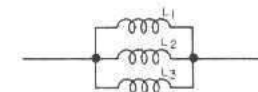

of inductance in parallel

$$Z = \frac{1}{\frac{1}{X_{L1}} + \frac{1}{X_{L2}} + \frac{1}{X_{L3}} \dots \text{etc.}}$$

$$\theta = +90^\circ$$



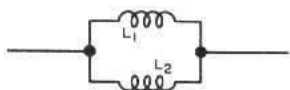

or where only 2 inductances  $L_1$  and  $L_2$  are involved,

$$Z = 2\pi f \left( \frac{L_1 L_2}{L_1 + L_2} \right)$$

$$\theta = +90^\circ$$

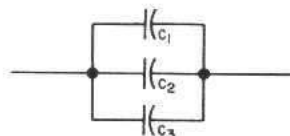

of capacitance in parallel

$$Z = \frac{1}{\frac{1}{X_{C1}} + \frac{1}{X_{C2}} + \frac{1}{X_{C3}} \dots \text{etc.}}$$

$$\theta = -90^\circ$$

or where only 2 capacitances  $C_1$  and  $C_2$  are involved,

$$Z = \frac{1}{2\pi f (C_1 + C_2)}$$

$$\theta = -90^\circ$$

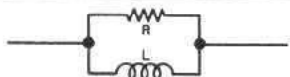

of inductance and resistance in parallel,

$$Z = \frac{RX_L}{\sqrt{R^2 + X_L^2}}$$

$$\theta = \arctan \frac{R}{X_L}$$

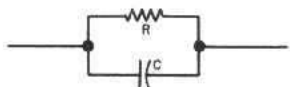

of capacitance and resistance in parallel,

$$Z = \frac{RX_C}{\sqrt{R^2 + X_C^2}}$$

$$\theta = -\arctan \frac{R}{X_C}$$

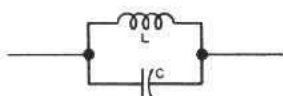

of inductance and capacitance in parallel,

$$Z = \frac{X_L X_C}{X_L - X_C}$$

$$\theta = 0^\circ \text{ when } X_L = X_C$$

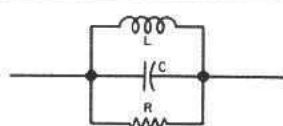

of inductance, resistance and capacitance in parallel

$$Z = \frac{RX_L X_C}{\sqrt{X_L^2 X_C^2 + (RX_L - RX_C)^2}}$$

$$\theta = \arctan \frac{RX_C - RX_L}{X_L X_C}$$

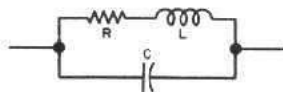

of inductance and series resistance in parallel with capacitance

$$Z = X_C \sqrt{\frac{R^2 + X_L^2}{R^2 + (X_L - X_C)^2}}$$

$$\theta = \arctan \left( \frac{X_L X_C - X_L^2 - R^2}{RX_C} \right)$$

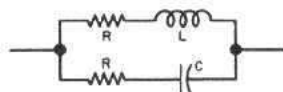

of capacitance and series resistance in parallel with inductance and series resistance

$$Z = \sqrt{\frac{(R_L^2 + X_L^2)(R_C^2 + X_C^2)}{(R_L + R_C)^2 + (X_L - X_C)^2}}$$

$$\theta = \arctan \frac{X_L(R_C^2 + X_C^2) - X_C(R_L^2 + X_L^2)}{R_L(R_C^2 + X_C^2) + R_C(R_L^2 + X_L^2)}$$

**Conductance**

In direct current circuits, conductance is expressed by

$$G = \frac{1}{R}$$

where  $G$  = conductance in mhos,  
 $R$  = resistance in ohms.

In d-c circuits involving resistances  $R_1, R_2, R_3$ , etc., in parallel,

the total conductance is expressed by

$$G_{\text{total}} = G_1 + G_2 + G_3 \dots \text{etc.}$$

and the total current by

$$I_{\text{total}} = E G_{\text{total}}$$

and the amount of current in any single resistor,  $R_2$  for example, in a parallel group, by

$$I_2 = \frac{I_{\text{total}} G_2}{G_1 + G_2 + G_3 \dots \text{etc.}}$$

$R, E$  and  $I$  in Ohm's law formulas for d-c circuits may be expressed in terms of conductance as follows:

$$R = \frac{1}{G}, \quad E = \frac{I}{G}, \quad I = EG,$$

where  $G$  = conductance in mhos,  
 $R$  = resistance in ohms,  
 $E$  = potential in volts,  
 $I$  = current in amperes.

**Susceptance**

In an alternating current circuit, the susceptance of a series circuit is expressed by

$$B = \frac{X}{R^2 + X^2}$$

or, when the resistance is 0, susceptance becomes the reciprocal of reactance, or

$$B = \frac{1}{X}$$

where  $B$  = susceptance in mhos,  
 $R$  = resistance in ohms,  
 $X$  = reactance in ohms.

**Admittance**

In an alternating current circuit, the admittance of a series circuit is expressed by

$$Y = \frac{1}{\sqrt{R^2 + X^2}}$$

Admittance is also expressed as the reciprocal of impedance, or

$$Y = \frac{1}{Z}$$

where  $Y$  = admittance in mhos,  
 $R$  = resistance in ohms,  
 $X$  = reactance in ohms,  
 $Z$  = impedance in ohms.

**R and X in Terms of G and B**

Resistance and reactance may be expressed in terms of conductance and susceptance as follows:

$$R = \frac{G}{G^2 + B^2}, \quad X = \frac{B}{G^2 + B^2}$$

**G, B, Y and Z in Parallel Circuits**

In any given a-c circuit containing a number of smaller parallel circuits only,

the effective conductance  $G_t$  is expressed by

$$G_t = G_1 + G_2 + G_3 \dots \text{etc.},$$

and the effective susceptance  $B_t$  by

$$B_t = B_1 + B_2 + B_3 \dots \text{etc.}$$

and the effective admittance  $Y_t$  by

$$Y_t = \sqrt{G_t^2 + B_t^2}$$

and the effective impedance  $Z_t$  by

$$Z_t = \frac{1}{\sqrt{G_t^2 + B_t^2}} \text{ or } \frac{1}{Y_t}$$

where  $R$  = resistance in ohms,  
 $X$  = reactance (capacitive or inductive) in ohms,  
 $G$  = conductance in mhos,  
 $B$  = susceptance in mhos,  
 $Y$  = admittance in mhos,  
 $Z$  = impedance in ohms.

## Transient $I$ and $E$ in LCR Circuits

The formulas which follow may be used to closely approximate the growth and decay of current and voltage in circuits involving  $L$ ,  $C$  and  $R$ :

- where  $i$  = instantaneous current in amperes at any given time ( $t$ ),
- $E$  = potential in volts as designated,
- $R$  = circuit resistance in ohms,
- $C$  = capacitance in farads,
- $L$  = inductance in henrys,
- $V$  = steady state potential in volts,
- $V_C$  = reactive volts across  $C$ ,
- $V_L$  = reactive volts across  $L$ ,
- $V_R$  = voltage across  $R$

$RC$  = time constant of  $RC$  circuit in seconds,

$\frac{L}{R}$  = time constant of  $RL$  circuit in seconds,

$t$  = any given time in seconds after switch is thrown,

$\epsilon$  = a constant, 2.718 (base of the natural system of logarithms),

$Sw$  = switch

The **time constant** is defined as the time in seconds for current or voltage to fall to  $\frac{1}{\epsilon}$  or 36.8% of its initial value or to rise to  $(1 - \frac{1}{\epsilon})$  or approximately 63.2% of its final value.

### Charging a De-energized Capacitive Circuit

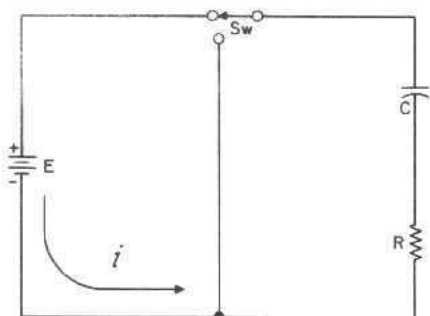

$E$  = applied potential.

$$i = \frac{E}{R} \epsilon^{-\frac{t}{RC}}$$

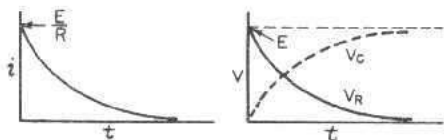

$$V_C = E \left( 1 - \epsilon^{-\frac{t}{RC}} \right) \quad V_R = E \epsilon^{-\frac{t}{RC}}$$

### Discharging an Energized Capacitive Circuit

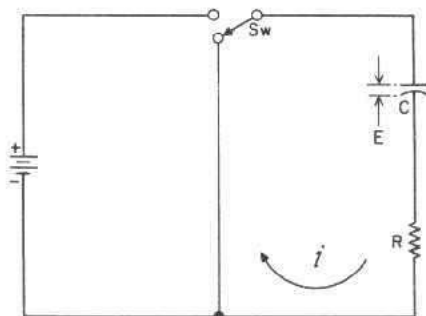

$E$  = potential to which  $C$  is charged prior to closing  $Sw$ .

$$i = \frac{E}{R} \epsilon^{-\frac{t}{RC}}$$

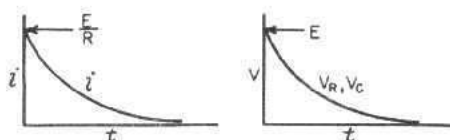

$$V_C = V_R = E \epsilon^{-\frac{t}{RC}}$$

**Voltage is Applied to a De-energized Inductive Circuit**

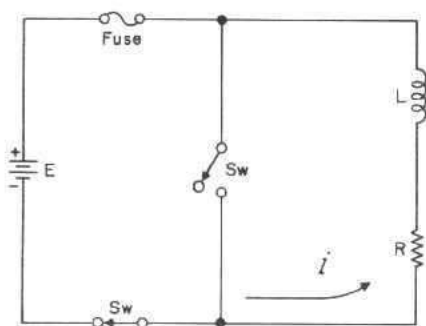

$E =$  applied potential

$$i = \frac{E}{R} \left( 1 - e^{-\frac{Rt}{L}} \right)$$

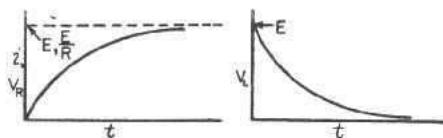

$$V_R = E \left( 1 - e^{-\frac{Rt}{L}} \right)$$

$$V_L = E e^{-\frac{Rt}{L}}$$

**An Energized Inductive Circuit is Short Circuited**

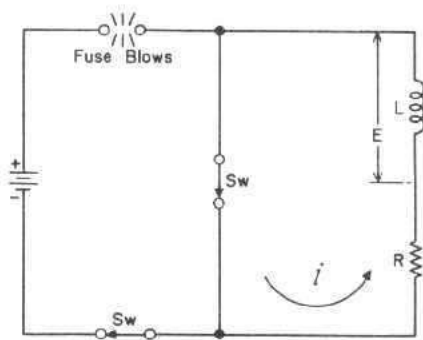

$E =$  counter potential induced in coil when switch is closed.

$$i = \frac{E}{R} e^{-\frac{Rt}{L}}$$

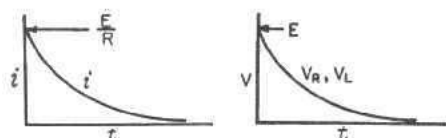

$$V_L = V_R = E e^{-\frac{Rt}{L}}$$

**Steady State Current Flow**

**In a Capacitive Circuit**

In a capacitive circuit, where resistance loss components may be considered as negligible, the flow of current at a given alternating potential of constant frequency, is expressed by

$$I = \frac{E}{X_C} = \frac{E}{\left( \frac{1}{2\pi fC} \right)} = E (2\pi fC)$$

where  $I =$  current in amperes,  
 $X_C =$  capacitive reactance of the circuit in ohms,  
 $E =$  applied potential in volts.

**In an Inductive Circuit**

In an inductive circuit, where inherent resistance and capacitance components may be so low as to be negligible, the flow of current at a given alternating potential of a constant frequency, is expressed by

$$I = \frac{E}{X_L} = \frac{E}{2\pi fL}$$

where  $I =$  current in amperes,  
 $X_L =$  inductive reactance of the circuit in ohms,  
 $E =$  applied potential in volts.

## Transmission Line Formulas

### Concentric Transmission Lines

Characteristic impedance in ohms is given by

$$Z = 138 \log \frac{d_1}{d_2}$$

R-f resistance in ohms per foot of copper line, is given by

$$r = \sqrt{f} \left( \frac{1}{d_1} + \frac{1}{d_2} \right) \times 10^{-3}$$

Attenuation in decibels per foot of line, is given by

$$\alpha = \frac{4.6\sqrt{f}(d_1 + d_2)}{d_1 d_2 \left( \log \frac{d_1}{d_2} \right)} \times 10^{-6}$$

where  $Z$  = characteristic impedance in ohms,

$r$  = radio frequency resistance in ohms per foot of copper line,

$\alpha$  = attenuation in decibels per foot of line,

$d_1$  = the inside diameter of the outer conductor, expressed in inches,

$d_2$  = the outside diameter of the inner conductor, expressed in inches,

$f$  = frequency in megacycles.

### Two-Wire Open Air Transmission Lines

Characteristic impedance in ohms is given by

$$Z = 276 \left( \log \frac{2D}{d} \right)$$

Inductance in microhenrys per foot of line is given by

$$L = 0.281 \left( \log \frac{2D}{d} \right)$$

Capacitance in micromicrofarads per foot of line is given by

$$C = \frac{3.68}{\log \frac{2D}{d}}$$

Attenuation in decibels per foot of wire is given by

$$db = \frac{0.0157 R_f}{\log \frac{2D}{d}}$$

R-f resistance in Ohms per loop-foot of wire, is given by

$$R_f = \frac{2 \times 10^{-3} \sqrt{f}}{d}$$

where  $Z$  = characteristic impedance in ohms,

$D$  = spacing between wire centers in inches,

$d$  = the diameter of the conductors in inches,

$L$  = inductance in microhenrys per foot of line,

$C$  = capacitance in micromicrofarads per foot of line,

$db$  = attenuation in decibels per foot of wire,

$R_f$  = r-f resistance in ohms per loop-foot of wire,

$f$  = frequency in megacycles.

### Vertical Antenna

The capacitance of a vertical antenna, shorter than one-quarter wave length at its operating frequency, is given by

$$C_a = \frac{17l}{\left[ \left( \log \epsilon \frac{24l}{d} \right) - 1 \right] \left[ 1 - \left( \frac{fl}{246} \right)^2 \right]}$$

where  $C_a$  = capacitance of the antenna in micromicrofarads,

$l$  = height of antenna in feet,

$d$  = diameter of antenna conductor in inches,

$f$  = operating frequency in megacycles,

$\epsilon$  = 2.718 (the base of the natural system of logarithms).

## Vacuum Tube Formulas and Symbols

### Vacuum Tube Constants

Amplification factor ( $Mu$  or  $\mu$ ) is given by

$$\mu = \frac{\Delta E_p}{\Delta E_g} \text{ (with } I_p \text{ constant)}$$

Dynamic plate resistance in ohms, is given by

$$r_p = \frac{\Delta E_p}{\Delta I_p} \text{ (with } E_g \text{ constant)}$$

Mutual conductance in mhos, is given by

$$g_m = \frac{\Delta I_p}{\Delta E_g} \text{ (with } E_p \text{ constant)}$$

### Vacuum Tube Formulas

Gain per stage is given by

$$\mu \left( \frac{R_L}{R_L + r_p} \right)$$

Voltage output appearing in  $R_L$  is given by

$$\mu \left( \frac{E_s R_L}{r_p + R_L} \right)$$

Power output in  $R_L$ , is given by

$$R_L \left( \frac{\mu E_s}{r_p + R_L} \right)^2$$

Maximum power output in  $R_L$  which results when  $R_L = r_p$ , is given by

$$\frac{(\mu E_s)^2}{4r_p}$$

Maximum undistorted power output in  $R_L$ , which results when  $R_L = 2r_p$ , is given by

$$\frac{2(\mu E_s)^2}{9r_p}$$

Required cathode biasing resistor in ohms, for a single tube is given by

$$\frac{E_g}{I_k}$$

### Vacuum Tube Symbols

$Mu$  or  $\mu$  = Amplification factor,

$r_p$  = Dynamic plate resistance in ohms,

$g_m$  = Mutual conductance in mhos,

$E_p$  = Plate voltage in volts,

$E_g$  = Grid voltage in volts,

$I_p$  = Plate current in amperes,

$R_L$  = Plate load resistance in ohms,

$I_k$  = Total cathode current in amperes,

$E_s$  = Signal voltage in volts,

$\Delta$  = change or variation in value, which may be either an increment (increase), or a decrement (decrease).

## Peak, R.M.S., and Average A-C Values of E & I

Given Value	To get . . .		
	Peak	R.M.S.	Av.
Peak		$0.707 \times \text{Peak}$	$0.637 \times \text{Peak}$
R.M.S.	$1.41 \times \text{R.M.S.}$		$0.9 \times \text{R.M.S.}$
Av.	$1.57 \times \text{Av.}$	$1.11 \times \text{Av.}$	

## D-C Meter Formulas

### Meter Resistance

The d-c resistance of a milliammeter or voltmeter movement may be determined as follows:

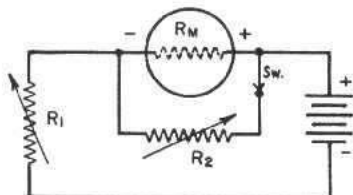

1. Connect the meter in series with a suitable battery and variable resistance  $R_1$  as shown in the diagram above.
2. Vary  $R_1$  until a full scale reading is obtained.
3. Connect another variable resistor  $R_2$  across the meter and vary its value until a half scale reading is obtained.
4. Disconnect  $R_2$  from the circuit and measure its d-c resistance.

The meter resistance  $R_m$  is equal to the measured resistance of  $R_2$ .

**Caution:** Be sure that  $R_1$  has sufficient resistance to prevent an off scale reading of the meter. The correct value depends upon the sensitivity of meter, and voltage of the battery. The following formula can be used if the full scale current of the meter is known:

$$R_1 = \frac{\text{voltage of the battery used}}{\text{full scale current of meter in amperes}}$$

For safe results, use twice the value computed. Also, never attempt to measure the resistance of a meter with an ohmmeter. To do so would in all probability result in a burned-out or severely damaged meter, since the current required for the operation of some ohmmeters and bridges is far in excess of the full scale current required by the movement of the average meter you may be checking.

### Ohms per Volt Rating of a Voltmeter

$$\Omega/V = \frac{1}{I_{fs}}$$

where  $\Omega/V$  = ohms per volt,

$I_{fs}$  = full scale current in amperes.

### Fixed Current Shunts

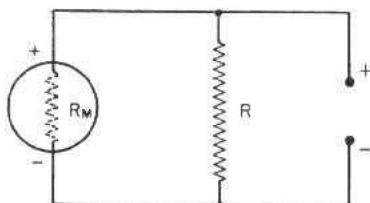

$$R = \frac{R_m}{N - 1}$$

$R$  = shunt value in ohms,

$N$  = the new full scale reading divided by the original full scale reading, both being stated in the same units,

$R_m$  = meter resistance in ohms.

### Multi-Range Shunts

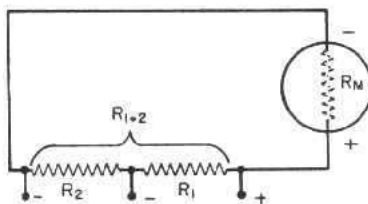

$$R_1 = \frac{R_{1+2} + R_m}{N}$$

$R_1$  = intermediate or tapped shunt value in ohms,

$R_{1+2}$  = total resistance required for the lowest scale reading wanted,

$R_m$  = meter resistance in ohms,

$N$  = the new full scale reading divided by the original full scale reading, both being stated in the same units,

**Voltage Multipliers**

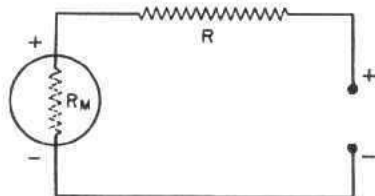

$$R = \frac{E_{fs}}{I_{fs}} - R_m$$

$R$  = multiplier resistance in ohms,  
 $E_{fs}$  = full scale reading required in volts,  
 $I_{fs}$  = full scale current of meter in amperes,  
 $R_m$  = meter resistance in ohms.

**Measuring Resistance**

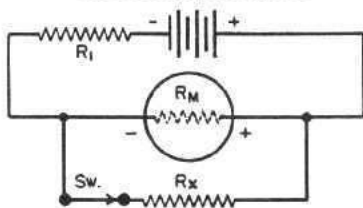

with Milliammeter and Battery\*

$$R_x = R_m \left( \frac{I_2}{I_1 - I_2} \right)$$

$R_x$  = unknown resistance in ohms,  
 $R_m$  = meter resistance in ohms, or effective meter resistance if a shunted range is used,  
 $I_1$  = current reading with switch open,  
 $I_2$  = current reading with switch closed,  
 $R_1$  = current limiting resistor of sufficient value to keep meter reading on scale when switch is open.

\* Approximately true only when current limiting resistor is large as compared to meter resistance.

**Shunt Values for 27-Ohm 0-1 Milliammeter**

FULL SCALE CURRENT	SHUNT RESISTANCE
0-10 ma	3.0 ohms
0-50 ma	0.551 ohms
0-100 ma	0.272 ohms
0-500 ma	0.0541 ohms

**Measuring Resistance—(Continued)**

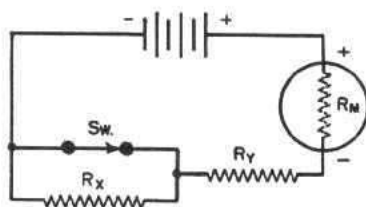

with Millimeter, Battery and Known Resistor

$$R_x = (R_v + R_m) \left( \frac{I_1 - I_2}{I_2} \right)$$

$R_x$  = unknown resistance in ohms,  
 $R_v$  = known resistance in ohms,  
 $R_m$  = meter resistance in ohms,  
 $I_1$  = current reading with switch closed,  
 $I_2$  = current reading with switch open.

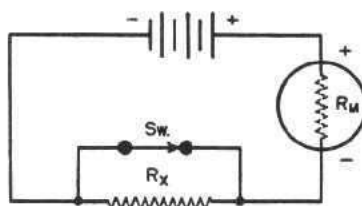

with Voltmeter and Battery

$$R_x = R_m \left( \frac{E_1}{E_2} - 1 \right)$$

$R_x$  = unknown resistance in ohms,  
 $R_m$  = meter resistance in ohms, including multiplier resistance if a multiplied range is used,  
 $E_1$  = voltmeter reading with switch closed,  
 $E_2$  = voltmeter reading with switch open.

**Multiplier Values for 27-Ohm 0-1 Milliammeter**

FULL SCALE VOLTAGE	MULTIPLIER RESISTANCE
0-10 volts	10,000 ohms
0-50 volts	50,000 ohms
0-100 volts	100,000 ohms
0-250 volts	250,000 ohms
0-500 volts	500,000 ohms
0-1,000 volts	1,000,000 ohms



## Ohm's Law for A-C Circuits

The fundamental Ohm's law formulas for a-c circuits are given by

$$I = \frac{E}{Z}, \quad Z = \frac{E}{I},$$

$$E = IZ, \quad P = EI \cos \theta$$

where  $I$  = current in amperes,  
 $Z$  = impedance in Ohms,  
 $E$  = volts across  $Z$ ,  
 $P$  = power in watts,  
 $\theta$  = phase angle in degrees.

### Phase Angle

The phase angle is defined as the difference in degrees by which current leads voltage in a capacitive circuit, or lags voltage in an inductive circuit, and in series circuits is equal to the angle whose tangent is given by the

ratio  $\frac{X}{R}$  and is expressed by

$$\text{arc tan } \frac{X}{R}$$

where  $X$  = the inductive or capacitive reactance in ohms,

$R$  = the non-reactive resistance in ohms,

of the combined resistive and reactive components of the circuit under consideration.

Therefore

in a purely resistive circuit,  $\theta = 0^\circ$   
 in a purely reactive circuit,  $\theta = 90^\circ$   
 and in a resonant circuit,  $\theta = 0^\circ$

also when

$\theta = 0^\circ$ ,  $\cos \theta = 1$  and  $P = EI$ ,  
 $\theta = 90^\circ$ ,  $\cos \theta = 0$  and  $P = 0$ .

Degrees  $\times 0.0175$  = radians.  
 1 radian =  $57.3^\circ$ .

### Power Factor

The power-factor of any a-c circuit is equal to the true power in watts divided by the apparent power in volt-amperes which is equal to the cosine of the phase angle, and is expressed by

$$p.f. = \frac{EI \cos \theta}{EI} = \cos \theta$$

where

$p.f.$  = the circuit load power factor,  
 $EI \cos \theta$  = the true power in watts,  
 $EI$  = the apparent power in volt-amperes,  
 $E$  = the applied potential in volts  
 $I$  = load current in amperes.

Therefore

in a purely resistive circuit.

$$\theta = 0^\circ \text{ and } p.f. = 1$$

and in a reactive circuit,

$$\theta = 90^\circ \text{ and } p.f. = 0$$

and in a resonant circuit,

$$\theta = 0^\circ \text{ and } p.f. = 1$$

### Ohm's Law for D-C Circuits

The fundamental Ohm's law formulas for d-c circuits are given by,

$$I = \frac{E}{R}, \quad R = \frac{E}{I},$$

$$E = IR, \quad P = EI.$$

where  $I$  = current in amperes,

$R$  = resistance in ohms,

$E$  = potential across  $R$  in volts,

$P$  = power in watts.

## Ohm's Law Formulas for D-C Circuits

Known Values	Formulas for Determining Unknown Values of . . .			
	<i>I</i>	<i>R</i>	<i>E</i>	<i>P</i>
<b><i>I &amp; R</i></b>			$IR$	$I^2R$
<b><i>I &amp; E</i></b>		$\frac{E}{I}$		$EI$
<b><i>I &amp; P</i></b>		$\frac{P}{I^2}$	$\frac{P}{I}$	
<b><i>R &amp; E</i></b>	$\frac{E}{R}$			$\frac{E^2}{R}$
<b><i>R &amp; P</i></b>	$\sqrt{\frac{P}{R}}$		$\sqrt{PR}$	
<b><i>E &amp; P</i></b>	$\frac{P}{E}$	$\frac{E^2}{P}$		

## Ohm's Law Formulas for A-C Circuits

Known Values	Formulas for Determining Unknown Values of . . .			
	<i>I</i>	<i>Z</i>	<i>E</i>	<i>P</i>
<b><i>I &amp; Z</i></b>			$IZ$	$I^2Z \cos \theta$
<b><i>I &amp; E</i></b>		$\frac{E}{I}$		$IE \cos \theta$
<b><i>I &amp; P</i></b>		$\frac{P}{I^2 \cos \theta}$	$\frac{P}{I \cos \theta}$	
<b><i>Z &amp; E</i></b>	$\frac{E}{Z}$			$\frac{E^2 \cos \theta}{Z}$
<b><i>Z &amp; P</i></b>	$\sqrt{\frac{P}{Z \cos \theta}}$		$\sqrt{\frac{PZ}{\cos \theta}}$	
<b><i>E &amp; P</i></b>	$\frac{P}{E \cos \theta}$	$\frac{E^2 \cos \theta}{P}$		

## Coil Winding Data

### Turns Per Inch

Gauge (AWG) or (B&S)	Number of Turns per Linear Inch			
	Enamel	S.S.C.	D.S.C. and S.C.C.	D.C.C.
1	—	—	3.3	3.3
2	—	—	3.8	3.6
3	—	—	4.2	4.0
4	—	—	4.7	4.5
5	—	—	5.2	5.0
6	—	—	5.9	5.6
7	—	—	6.5	6.2
8	7.6	—	7.4	7.1
9	8.6	—	8.2	7.8
10	9.6	—	9.3	8.9
11	10.7	—	10.3	9.8
12	12.0	—	11.5	10.9
13	13.5	—	12.8	12.0
14	15.0	—	14.2	13.8
15	16.8	—	15.8	14.7
16	18.9	18.9	17.9	16.4
17	21.2	21.2	19.9	18.1
18	23.6	23.6	22.0	19.8
19	26.4	26.4	24.4	21.8
20	29.4	29.4	27.0	23.8
21	33.1	32.7	29.8	26.0
22	37.0	36.5	34.1	30.0
23	41.3	40.6	37.6	31.6
24	46.3	45.3	41.5	35.6
25	51.7	50.4	45.6	38.6
26	58.0	55.6	50.2	41.8
27	64.9	61.5	55.0	45.0
28	72.7	68.6	60.2	48.5
29	81.6	74.8	65.4	51.8
30	90.5	83.3	71.5	55.5
31	101.	92.0	77.5	59.2
32	113.	101.	83.6	62.6
33	127.	110.	90.3	66.3
34	143.	120.	97.0	70.0
35	158.	132.	104.	73.5
36	175.	143.	111.	77.0
37	198.	154.	118.	80.3
38	224.	166.	126.	83.6
39	248.	181.	133.	86.6
40	282.	194.	140.	89.7

### Coil Winding Formulas

The following approximations for winding *r-f* coils are accurate to within approx. 1% for nearly all small air-core coils, where

- $L$  = self inductance in microhenrys,
- $N$  = total number of turns,
- $r$  = mean radius in inches,
- $l$  = length of coil in inches,
- $b$  = depth of coil in inches.

#### Single-Layer Wound Coils

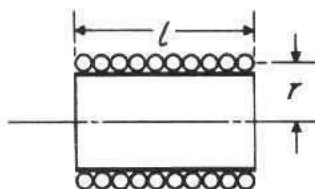

$$L = \frac{(rN)^2}{9r + 10l}$$

$$N = \frac{\sqrt{L(9r + 10l)}}{r}$$

#### Multi-Layer Wound Coils

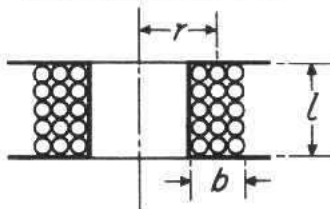

$$L = \frac{0.8(rN)^2}{6r + 9l + 10b}$$

#### Single-Layer Spiral Wound Coils

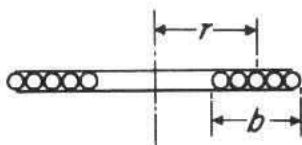

$$L = \frac{(rN)^2}{8r + 11b}$$

**Table of Standard Annealed Bare Copper Wire  
Using American Wire Gauge (B & S)**

Gauge (AWG) or (B & S)	DIAMETER INCHES			AREA	WEIGHT	LENGTH	RESISTANCE AT 68° F			Current* Capacity (Amperes) — Rubber Insulated
	Min.	Nom.	Max.	Circular Mils	Pounds per M'	Feet per Lb.	Ohms per M'	Feet per Ohm	Ohms per Lb.	
<b>0000</b>	.4554	.4600	.4646	211600.	640.5	1.561	.04901	20400.	.00007652	<b>225</b>
<b>000</b>	.4055	.4096	.4137	167800.	507.9	1.968	.06180	16180.	.0001217	<b>175</b>
<b>00</b>	.3612	.3648	.3684	133100.	402.8	2.482	.07793	12830.	.0001935	<b>150</b>
<b>0</b>	.3217	.3249	.3281	105500.	319.5	3.130	.09827	10180.	.0003076	<b>125</b>
<b>1</b>	.2864	.2893	.2922	83690.	253.3	3.947	.1239	8070.	.0004891	<b>100</b>
<b>2</b>	.2550	.2576	.2602	66370.	200.9	4.977	.1563	6400.	.0007778	<b>90</b>
<b>3</b>	.2271	.2294	.2317	52640.	159.3	6.276	.1970	5075.	.001237	<b>80</b>
<b>4</b>	.2023	.2043	.2063	41740.	126.4	7.914	.2485	4025.	.001966	<b>70</b>
<b>5</b>	.1801	.1819	.1837	33100.	100.2	9.980	.3133	3192.	.003127	<b>55</b>
<b>6</b>	.1604	.1620	.1636	26250.	79.46	12.58	.3951	2531.	.004972	<b>50</b>
<b>7</b>	.1429	.1443	.1457	20820.	63.02	15.87	.4982	2007.	.007905	
<b>8</b>	.1272	.1285	.1298	16510.	49.98	20.01	.6282	1592.	.01257	<b>35</b>
<b>9</b>	.1133	.1144	.1155	13090.	39.63	25.23	.7921	1262.	.01999	
<b>10</b>	.1009	.1019	.1029	10380.	31.43	31.82	.9989	1001.	.03178	<b>25</b>
<b>11</b>	.08983	.09074	.09165	8234.	24.92	40.12	1.260	794.	.05053	
<b>12</b>	.08000	.08081	.08162	6530.	19.77	50.59	1.588	629.6	.08035	<b>20</b>
<b>13</b>	.07124	.07196	.07268	5178.	15.68	63.80	2.003	499.3	.1278	
<b>14</b>	.06344	.06408	.06472	4107.	12.43	80.44	2.525	396.0	.2032	<b>15</b>
<b>15</b>	.05650	.05707	.05764	3257.	9.858	101.4	3.184	314.0	.3230	
<b>16</b>	.05031	.05082	.05133	2583.	7.818	127.9	4.016	249.0	.5136	<b>6</b>
<b>17</b>	.04481	.04526	.04571	2048.	6.200	161.3	5.064	197.5	.8167	
<b>18</b>	.03990	.04030	.04070	1624.	4.917	203.4	6.385	156.5	1.299	<b>3</b>
<b>19</b>	.03553	.03589	.03625	1288.	3.899	256.5	8.051	124.2	2.065	
<b>20</b>	.03164	.03196	.03228	1022.	3.092	323.4	10.15	98.5	3.283	
<b>21</b>	.02818	.02846	.02874	810.1	2.452	407.8	12.80	78.11	5.221	
<b>22</b>	.02510	.02535	.02560	642.4	1.945	514.2	16.14	61.95	8.301	
<b>23</b>	.02234	.02257	.02280	509.5	1.542	648.4	20.36	49.13	13.20	
<b>24</b>	.01990	.02010	.02030	404.0	1.223	817.7	25.67	38.96	20.99	
<b>25</b>	.01770	.01790	.01810	320.4	.9699	1031.	32.37	30.90	33.37	
<b>26</b>	.01578	.01594	.01610	254.1	.7692	1300.	40.81	24.50	53.06	
<b>27</b>	.01406	.01420	.01434	201.5	.6100	1639.	51.47	19.43	84.37	
<b>28</b>	.01251	.01264	.01277	159.8	.4837	2067.	64.90	15.41	134.2	
<b>29</b>	.01115	.01126	.01137	126.7	.3836	2607.	81.83	12.22	213.3	
<b>30</b>	.00993	.01003	.01013	100.5	.3042	3287.	103.2	9.691	339.2	
<b>31</b>	.008828	.008928	.009028	79.7	.2413	4145.	130.1	7.685	539.3	
<b>32</b>	.007850	.007950	.008050	63.21	.1913	5227.	164.1	6.095	857.6	
<b>33</b>	.006980	.007080	.007180	50.13	.1517	6591.	206.9	4.833	1364.	
<b>34</b>	.006205	.006305	.006405	39.75	.1203	8310.	260.9	3.833	2168.	
<b>35</b>	.005515	.005615	.005715	31.52	.09542	10480.	329.0	3.040	3448.	
<b>36</b>	.004900	.005000	.005100	25.00	.07568	13210.	414.8	2.411	5482.	
<b>37</b>	.004353	.004453	.004553	19.83	.06001	16660.	523.1	1.912	8717.	
<b>38</b>	.003865	.003965	.004065	15.72	.04759	21010.	659.6	1.516	13860.	
<b>39</b>	.003431	.003531	.003631	12.47	.03774	26500.	831.8	1.202	22040.	
<b>40</b>	.003045	.003145	.003245	9.888	.02993	33410.	1049.	0.9534	35040.	
<b>41</b>	.00270	.00280	.00290	7.8400	.02373	42140.	1323.	.7559	55750.	
<b>42</b>	.00239	.00249	.00259	6.2001	.01877	53270.	1673.	.5977	89120.	
<b>43</b>	.00212	.00222	.00232	4.9284	.01492	67020.	2104.	.4753	141000.	
<b>44</b>	.00187	.00197	.00207	3.8809	.01175	85100.	2672.	.3743	227380.	
<b>45</b>	.00166	.00176	.00186	3.0976	.00938	106600.	3348.	.2987	356890.	
<b>46</b>	.00147	.00157	.00167	2.4649	.00746	134040.	4207.	.2377	563900.	

\*Note: Values from National Electrical Code.

### Single-Layer Wound Coil Chart

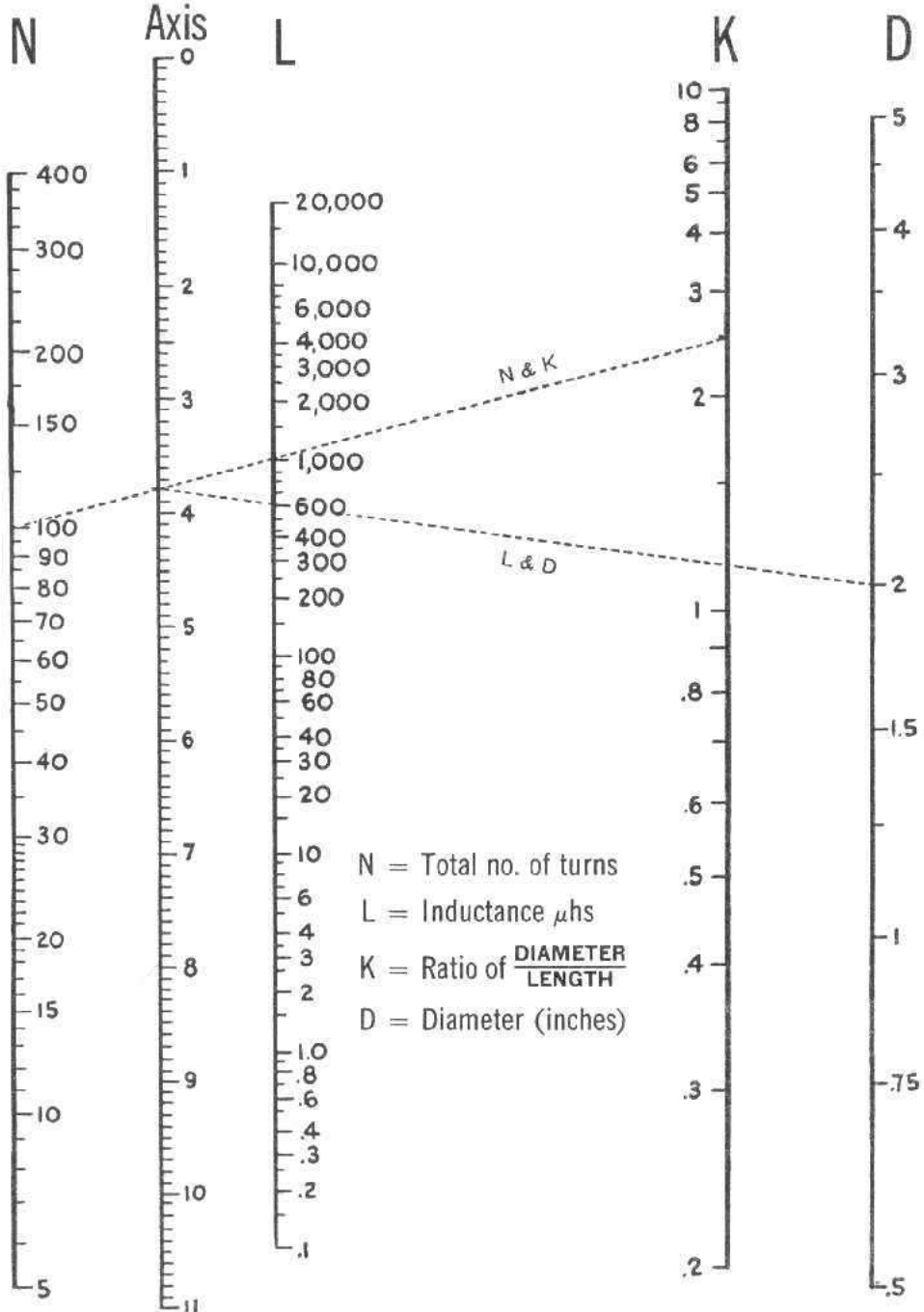

Courtesy, P. R. Mallory & Co., Inc.

## Single-Layer Wound Coil Chart

The chart on the opposite page provides a convenient means of determining the unknown factors of small sized single-layer wound r-f coils. Values thus found so closely approximate those determined by measurement or mathematical calculation as to be entirely satisfactory for all practical purposes of experimentation, design, and repair work. Since in all coils of this type, the difference between the mean and inner diameter of the winding is so slight as to be negligible, **D** in all instances may be either the mean or inner diameter as desired.

**Example:** Given the total number of turns, winding length and diameter of a coil,— to find the inductance;

1. Place a straightedge on the chart so as to form a line intersecting the number of turns **N**, and the ratio of diameter to length **K**, and note the point intersected on the linear axis column.

2. Now move the straightedge so as to form a second line which will intersect this same point on the axis column, and the diameter **D**.
3. The point where this line intersects the **L** column indicates the inductance of the coil in microhenries.

**Example:** Given the diameter, winding length and inductance in microhenries,— to find the number of turns;

1. Simply reverse the process outlined above for determining inductance.
2. After finding the number of turns, consult the wire table on page 26 and determine the size of wire to be used.

The dotted lines appearing on the chart illustrate the correct plotting of a 600-microhenry coil consisting of 100 turns of wire, wound to 51/64" on a form 2" in diameter.

## Inductance, Capacitance, Reactance Charts

The direct-reading charts appearing on the following three pages are designed for determining unknown values of frequency, inductance, capacitance and reactance components operating in a-f and r-f circuits.

The simplifications embodied in these charts make them extremely useful. The frequency range covered comprises the frequency spectrum from 1 cycle per second up to 1000 megacycles per second. All of the scales involved are plotted in actual magnitudes so that no computations are required to determine the location of the decimal point in the final result.

To make these conditions possible the frequency spectrum has been divided into three parts:

**Chart I** (page 30)—Covers the range from 1 cycle to 1000 cycles.

**Chart II** (page 31)—From 1 kilocycle to 1000 kilocycles.

**Chart III** (page 32)—From 1 megacycle to 1000 megacycles.

Inductance, capacitance, reactance and frequency have been plotted so that the reactance offered by an inductance or capacitance at any frequency may be readily determined by placing a straight-edge across the chart connecting the known quantities.

Since  $X_L = X_C$  at resonance in most radio circuits, the charts may also be used to find the resonant frequency of any combination of *L* and *C*.

To illustrate with a simple example, suppose the reactance of a 0.01  $\mu\text{f}$ . capacitor is desired at a frequency of 400 cycles. Place a straight-edge across the proper chart so as to connect the points 0.01  $\mu\text{f}$ . and 400 cycles per sec. The quantity desired is the point of intersection with the reactance scale which is 40,000 ohms. The straight-edge also intersects the inductance scale at 15.8 henrys indicating that this value of inductance likewise has a reactance of 40,000 ohms at 400 cycles per sec. and furthermore, that these values of *L* and *C* produce resonance at this frequency.

There are many practical uses for these charts. The radio experimenter, maintenance man and engineer will find them helpful in the rapid solution of many reactance problems. Unusual care was exercised in laying out the various scales in order to secure a high degree of accuracy for the charts. Results should be obtainable which are at least as accurate as might be secured with a ten-inch slide rule.

Inductance, Capacitance, Reactance—(Continued)

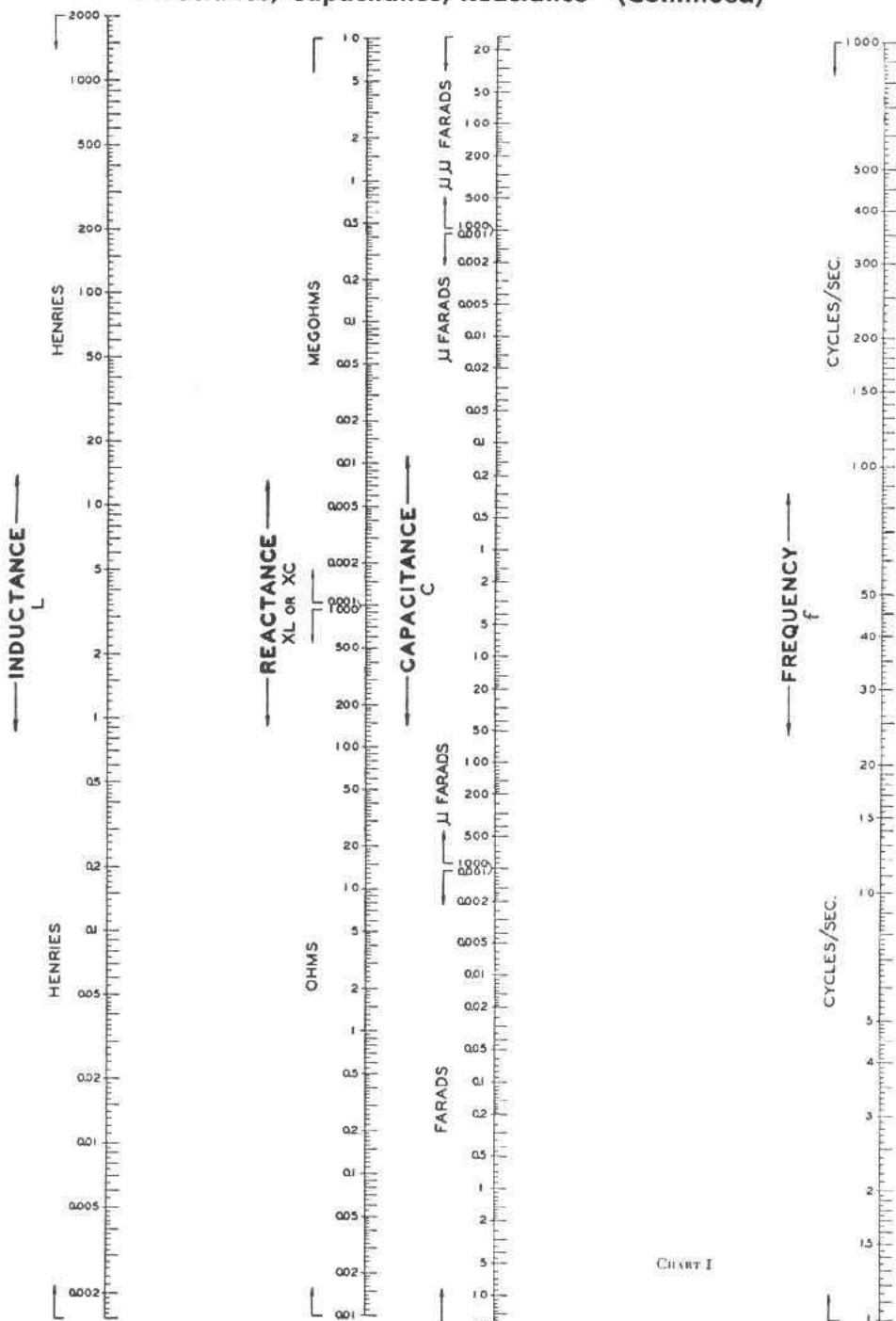

CHART I

Courtesy, Sylvania Electric Products Inc.

Inductance, Capacitance, Reactance—(Continued)

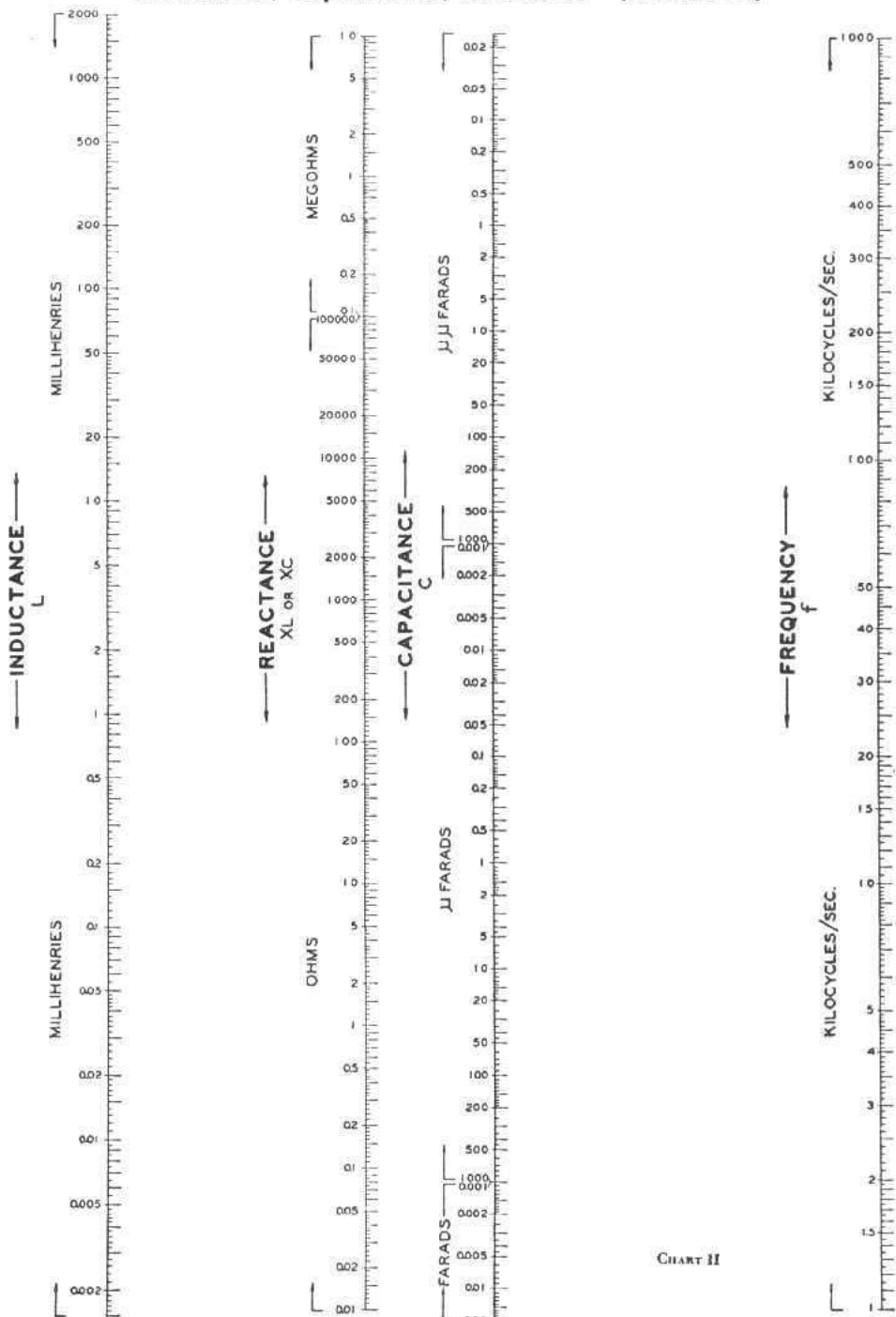

CHART II

Courtesy, Sylvania Electric Products Inc.



Inductance, Capacitance, Reactance—(Continued)

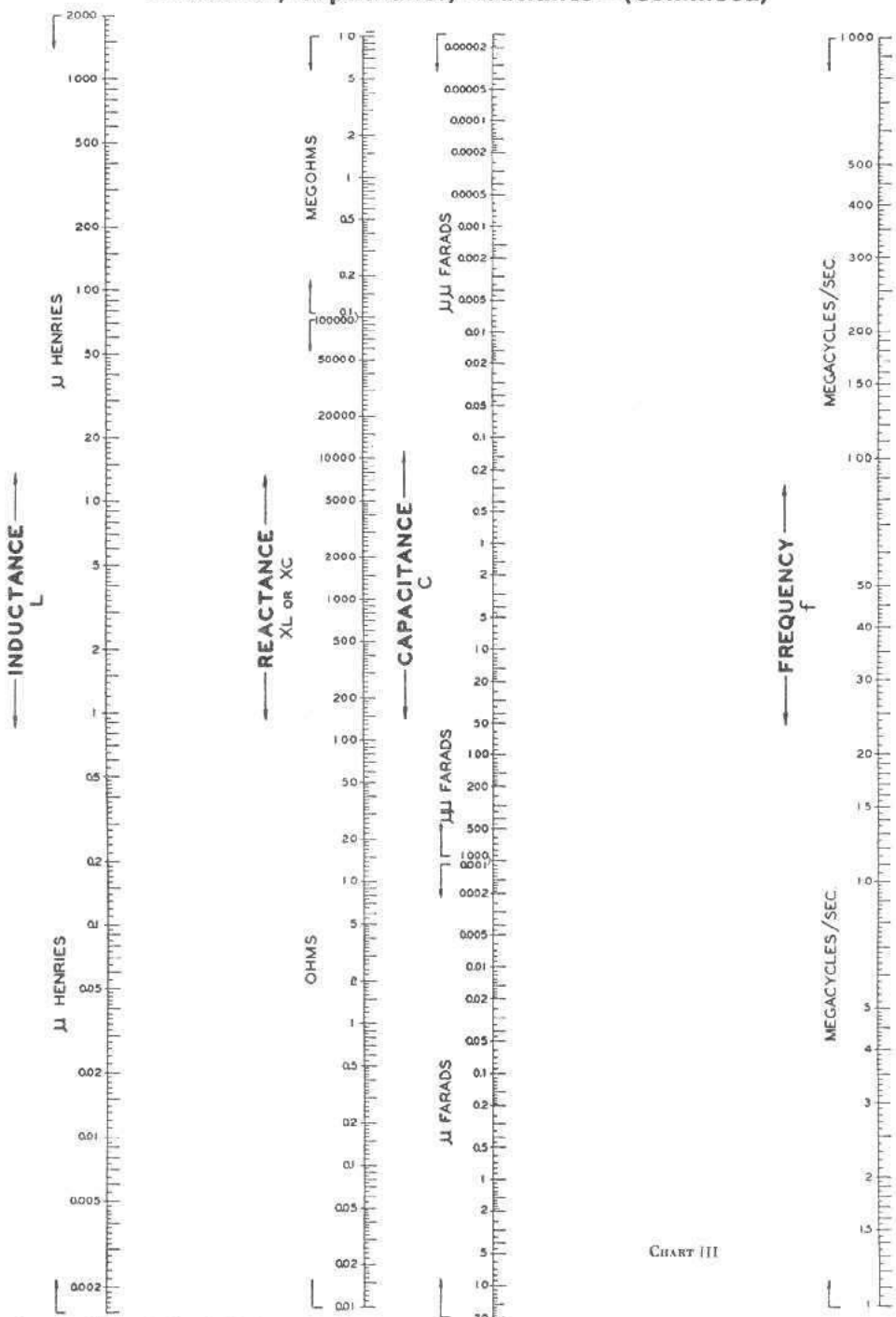

CHART III

Courtesy, Sylvania Electric Products Inc.

## How to Use Logarithms

Logarithms are used to simplify numerical computations involving multiplications, division, powers and roots. With logarithms, multiplication is reduced to simple addition, and division is reduced to simple subtraction. Raising to a power is reduced to a single multiplication, and extracting a root is reduced to a single division.

The common logarithm of any number is the power to which 10 must be raised in order to equal that number.

Therefore, since

$$\begin{aligned} 1000 &= 10^3 \\ 100 &= 10^2 \\ 10 &= 10^1 \\ 1 &= 10^0 \\ 0.1 &= 10^{-1} \\ 0.01 &= 10^{-2} \\ 0.001 &= 10^{-3} \\ 0.0001 &= 10^{-4} \end{aligned}$$

it is true that

$$\begin{aligned} \log 1000 &= 3 \\ \log 100 &= 2 \\ \log 10 &= 1 \\ \log 1 &= 0 \\ \log 0.1 &= -1 \\ \log 0.01 &= -2 \\ \log 0.001 &= -3 \\ \log 0.0001 &= -4 \end{aligned}$$

The common system of logarithms has for its base the number 10, and is written  $\log_{10}$  or more commonly  $\log$ , since the base 10 is always implied unless some other base is specifically indicated. There are formulas however which use the natural system of logarithms. This system has for its base the number 2.718... which is represented by the Greek letter  $e$  and is always written  $\log e$ .

A table of natural logarithms has not been included in this handbook however, since the common log of a number is approximately equal to 2.3026 times the natural log of the same number. Conversely, the natural log of a number is approximately equal to 0.4343 times the common log of the same number.

In observing the following exponential and logarithmic relationships,

Exponential Form	Logarithmic Form
100 = $10^2$	$\log 100 = 2.000$
15 = $10^{1.176}$	$\log 15 = 1.176$
10 = $10^1$	$\log 10 = 1.000$
7 = $10^{0.845}$	$\log 7 = 0.845$
1 = $10^0$	$\log 1 = 0.000$
0.1 = $10^{-1}$	$\log 0.1 = -1.000$
0.7 = $10^{-1.845}$	$\log 0.7 = -1.845$
0.15 = $10^{-2.176}$	$\log 0.15 = -2.176$
0.001 = $10^{-3}$	$\log 0.001 = -3.000$

it will be seen that only the direct powers of 10 have whole numbers for logarithms; also that the logarithms of all numbers lying between a power of 10, consist of a whole number and a decimal. The whole number is called the characteristic, and the decimal, the mantissa. Since the characteristic serves only to fix the location of the decimal point in the expression indicated by the  $\log$ , it can be found by inspection and is not included in the  $\log$  table. The following will be helpful:

1. The characteristic of any number greater than 1 is always positive and is equal to one less than the number of digits to the left of the decimal.
2. The characteristic of any number less than 1 is always negative and is equal to one plus the number of zeros to the decimal.
3. The characteristic of any number may be determined by expressing the number as a power of 10 and using this power as the characteristic of the logarithm for that number.

Since only the characteristic of a logarithm is ever negative, the mantissa always being a positive number, it is customary to write a  $\log$  containing a negative characteristic as follows:

$$\log 0.7 = \bar{1}.845,$$

or, by adding +10 to the characteristic and, in order to maintain equality, -10 at the right of the characteristic,

$$\log 0.7 = 9.845 - 10$$

Examples:

150	$1.5 \times 10^2$	2
15	$1.5 \times 10^1$	1
1.5	$1.5 \times 10^0$	0
0.15	$1.5 \times 10^{-1}$	-1 or 9 - 10
0.015	$1.5 \times 10^{-2}$	-2 or 8 - 10
0.0015	$1.5 \times 10^{-3}$	-3 or 7 - 10

Therefore, to find the logarithm of any number:

1. Write the number as a power of 10, and put down the resulting exponent of 10 as the characteristic.
2. Determine the mantissa from the log tables on page 56, and write this as a decimal figure following the characteristic.
3. If the resulting logarithm has a negative characteristic, change this to the positive form.

Example: Find the logarithm of .00623:

Since  $.00623 = 6.23 \times 10^{-3}$ , the characteristic is -3. The mantissa as shown by the log table is 7945. The resultant logarithm = 3.7945 or when written in its positive form, 7.7945 - 10.

To find the log of any number having more than three significant figures (by interpolation):

1. Determine the characteristic.
2. Find the mantissa corresponding to the first three significant figures.
3. Find the next higher mantissa and take the tabular difference.
4. Find the product of the tabular difference and the digit following the first three significant figures of the given number written as a decimal.
5. Add this product to the lesser mantissa.

Example: Find the logarithm of 54.65.

Since  $54.65 = 5.465 \times 10^1$ , the characteristic is 1.

Next higher mantissa = .7380

Next lower mantissa = .7372

Tabular difference = .0008

	$\times .5$	
Product	.00040	
Plus lesser mantissa	.7372	
Mantissa of 5.465	.7376	

$\therefore \log 54.65 = 1.7376$

Although a four-place log table is used here, for purposes where accuracy to 3 significant figures is required, generally, a three place table is sufficiently accurate for all practical purposes. Since the mantissa of a logarithm represents only the significant figures of any number, the same mantissa is used for .04, 4, 400, etc., the decimal point being fixed later by the characteristic. Therefore any number consisting of 1 or 2 significant figures may be found in the column marked **N**, and its mantissa will be found on the same line in this column headed by **0**. For any number containing 3 significant figures, locate the first two figures in the **N** column, and the third figure in the column headed by the corresponding digit. The mantissa will be found in this column, on a line even with the first two digits.

Example:

log	21	= 1.3222
log	2.1	= 0.3222
log	210	= 2.3222
log	.0021	= 7.3222 - 10
log	213	= 2.3284
log	.0213	= 9.3284 - 10
log	3	= 0.4771
log	300	= 2.4771
log	.003	= 7.4771 - 10

The number corresponding to a given logarithm is called the antilogarithm, and is written "antilog". Example: Since log of 692 = 2.8401, the antilog of 2.8401 = 692.

Finding the antilog of a number is the reverse of finding the logarithm. First locate the mantissa in the log table, and determine its corresponding number. Now, place the decimal as indicated by the characteristic.

Example: To find the antilog of 3.9138, look up 9138 in the log table. Its corresponding number is 82, or expressed as a power of 10, equals  $8.2 \times 10^0$ . A characteristic of 3 means that 8.2 must be multiplied by  $10^3$ . Therefore, antilog 3.9138 =  $8.2 \times 10^3 = 8200$ .

Similarly

Antilog 5.9138 =  $8.2 \times 10^5 = 82,0000$

Antilog 0.9138 =  $8.2 \times 10^0 = 8.2$

Antilog 7.9138 - 10 =  $8.2 \times 10^{-3} = 0.0082$

Antilog 9.9138 - 10 =  $8.2 \times 10^{-1} = 0.82$

To find the antilogarithm of a logarithm

whose mantissa is not exactly given in the table,

1. Find the tabular difference between the next highest and next lowest mantissas.
2. Divide this by the difference between the given mantissa and the next lowest mantissa.
3. Add the resulting quotient to the significant figures expressed by the next lower mantissa.
4. Place the decimal as indicated by the given characteristic.

**Example:** Find the antilog of 1.7376

Next higher mantissa .7380  
 Next lower mantissa .7372  
 Tabular difference .0008

Given mantissa .7376  
 Next lower mantissa .7372  
 Tabular difference .0004

$$\text{Quotient of } \frac{.0004}{.0008} = .5$$

The resultant figure therefore is .5 larger than the significant figures expressed by the lesser mantissa .7372 or 546. The sequence of figures therefore is 546.5

$$\therefore \text{the antilog of } 1.7376 = 54.65$$

**NOTE:** When interpolating as shown above, do not exceed four significant figures in your answer since interpolated results from a four-place table are not accurate beyond this point.

Logarithms are added or subtracted like arithmetical numbers, provided they are written with positive characteristics. If the characteristic in the total is greater than 9, and the notation -10, -20, -30, etc., appears after the mantissa, subtract a multiple of 10 from the positive part and add the same multiple of 10 to the negative part, so as to make the resultant characteristic less than 10.

**EXAMPLES:**

**Addition of logarithms**

2.764	6.326 - 10	6.328 - 10
4.304	6.284	7.764 - 10
7.068	12.610 - 10	9.104 - 10
	or	23.196 - 30
	2.610	or
		3.196 - 10

**Subtraction of logarithms**

4.107	{	=	14.107 - 10
6.986	}		6.986
			7.121 - 10
			11.672 - 10
			5.785 - 10
			5.887

The relationships of logarithmic operations are expressed by the following formulas:

$$\log(a \times b) = \log a + \log b$$

$$\log\left(\frac{a}{b}\right) = \log a - \log b$$

$$\log(a)^b = b \log a$$

$$\log \sqrt[b]{a} = \frac{\log a}{b}$$

**EXAMPLES**

**To Multiply** 1.24 by 246  
 log of 1.24 = 0.0934  
 log of 246 = 2.3909  
 Total 2.4843

The antilog of 2.4843 = 305, which is as accurate as can be determined with a four-place table. The full answer to this problem is 305.04.

**To Divide** 961 by 224  
 log of 961 = 2.9827  
 log of 224 = 2.3502  
 Difference 0.6325

The antilog of 0.6325 = 4.29 which is as accurate as can be determined with a four-place table. The product of 224 and 4.29 is 960.96.

**Powers:** Find 12<sup>2</sup> by logarithms:  
 log of 12 = 1.0792  
 $\times 2$   
 2.1584

The antilog of 2.1584 = 144.

**Roots** Find  $\sqrt[3]{343}$   
 log of 343 = 2.5353  $\div 3 = .8451$   
 The antilog of .8451 = 7.

**Logarithms of Negative Numbers.** Because the logarithms of negative numbers are imaginary in character, they cannot be used in computation as with positive numbers. However, since the numerical results of multiplying, dividing, etc., are not affected by the signs, you can determine the numerical results by logarithms and later affix the final + or - signs by inspection.

## Trigonometric Relationships

In any right triangle, if we let

$\theta$  = the acute angle formed by the hypotenuse and the base leg,

$\phi$  = the acute angle formed by the hypotenuse and the altitude leg,

$H$  = the hypotenuse,

$A$  = the side adjacent  $\theta$  and opposite  $\phi$ ,

$O$  = the side opposite  $\theta$  and adjacent  $\phi$ ,

then  $\text{sine of } \theta = \sin \theta = \frac{O}{H}$

$\text{cosine of } \theta = \cos \theta = \frac{A}{H}$

$\text{tangent of } \theta = \tan \theta = \frac{O}{A}$

$\text{cosecant of } \theta = \csc \theta = \frac{H}{O}$

$\text{secant of } \theta = \sec \theta = \frac{H}{A}$

$\text{cotangent of } \theta = \cot \theta = \frac{A}{O}$

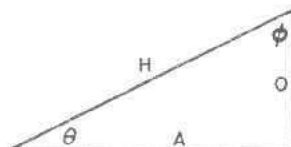

also  $\sin \theta = \cos \phi$        $\csc \theta = \sec \phi$   
 $\cos \theta = \sin \phi$        $\sec \theta = \csc \phi$   
 $\tan \theta = \cot \phi$        $\cot \theta = \tan \phi$

and  $\frac{1}{\sin \theta} = \csc \theta$        $\frac{1}{\csc \theta} = \sin \theta$   
 $\frac{1}{\cos \theta} = \sec \theta$        $\frac{1}{\sec \theta} = \cos \theta$   
 $\frac{1}{\tan \theta} = \cot \theta$        $\frac{1}{\cot \theta} = \tan \theta$

The expression "arc sin" indicates, "the angle whose sine is" . . . ; likewise arc tan indicates, "the angle whose tangent is" . . . etc. See formulas in table below.

Known Values	Formulas for Determining Unknown Values of . . .				
	A	O	H	$\theta$	$\phi$
A & O			$\sqrt{A^2 + O^2}$	$\text{arc tan } \frac{O}{A}$	$\text{arc tan } \frac{A}{O}$
A & H		$\sqrt{H^2 - A^2}$		$\text{arc cos } \frac{A}{H}$	$\text{arc sin } \frac{A}{H}$
A & $\theta$		$A \tan \theta$	$\frac{A}{\cos \theta}$		$90^\circ - \theta$
A & $\phi$		$\frac{A}{\tan \phi}$	$\frac{A}{\sin \phi}$	$90^\circ - \phi$	
O & H	$\sqrt{H^2 - O^2}$			$\text{arc sin } \frac{O}{H}$	$\text{arc cos } \frac{O}{H}$
O & $\theta$	$\frac{O}{\tan \theta}$		$\frac{O}{\sin \theta}$		$90^\circ - \theta$
O & $\phi$	$O \tan \phi$		$\frac{O}{\cos \phi}$	$90^\circ - \phi$	
H & $\theta$	$H \cos \theta$	$H \sin \theta$			$90^\circ - \theta$
H & $\phi$	$H \sin \phi$	$H \cos \phi$		$90^\circ - \phi$	

## Metric Relationships

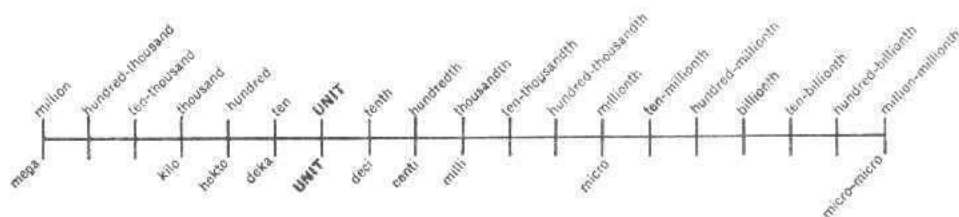

The above chart shows the relation between the American and the metric systems of notation.

This chart also serves to quickly locate the decimal point in the conversion from one metric expression to another.

**Example:** Convert 5.0 milliwatts to watts. Place the finger on milli and count the number of steps from there to units (since the

term watt is a basic unit). The number of steps so counted is three, and the direction was to the left. Therefore, 5.0 milliwatts is the equivalent of .005 watts.

**Example:** Convert 0.00035 microfarads to micromicrofarads. Here the number of steps counted will be six to the right. Therefore 0.00035 microfarads is the equivalent of 350 micromicrofarads.

## Metric Conversion Table

ORIGINAL VALUE	DESIRED VALUE							
	Mega	Kilo	Units	Deci	Centi	Milli	Micro	Micromicro
Mega		3 →	6 →	7 →	8 →	9 →	12 →	18 →
Kilo	← 3		3 →	4 →	5 →	6 →	9 →	15 →
Units	← 6	← 3		1 →	2 →	3 →	6 →	12 →
Deci	← 7	← 4	← 1		1 →	2 →	5 →	11 →
Centi	← 8	← 5	← 2	← 1		1 →	4 →	10 →
Milli	← 9	← 6	← 3	← 2	← 1		3 →	9 →
Micro	← 12	← 9	← 6	← 5	← 4	← 3		6 →
Micromicro	← 18	← 15	← 12	← 11	← 10	← 9	← 6	

The above metric conversion table provides a fast and automatic means of conversion from one metric notation to another. The notation "Unit" represents the basic units of measurement, such as amperes, volts, ohms, watts, cycles, meters, grams, etc. To use the table, first locate the original or given value in the left-hand column. Now follow this line horizontally to the vertical column headed by the prefix of the desired value. The figure and arrow at this point indicates number of places and direction decimal point is to be moved.

**Example:** Convert 0.15 ampere to milli-amperes. Starting at the "Units" box in the left-hand column (since ampere is a basic unit of measurement), move horizontally to the column headed by the prefix "Milli", and read 3 →. Thus 0.15 ampere is the equivalent of 150 milliamperes.

**Example:** Convert 50,000 kilocycles to megacycles. Read in the box horizontal to "Kilo" and under "Mega", the notation ← 3, which means a shift of the decimal three places to the left. Thus 50,000 kilocycles is the equivalent of 50 megacycles.

### Pilot Lamp Data

Maximum Size See Chart below for dimensions						
	A	1 1/2"	1 1/2"	7/8"	7/8"	1 1/4"
B	1 3/8"	3/4"	2 1/2"	1/2"	1/2"	3/4"
C	1 3/8"	1 3/8"	1 3/4"	1 3/4"	1 1/4"	1 1/4"
Bulb No.	T-3 1/4	T-3 1/4	G-3 1/2	G-3 1/2	G-4 1/2	G-5
Base	Screw (Miniature)	Bayonet (Miniature)	Screw (Miniature)	Bayonet (Miniature)	Bayonet (Miniature)	Bayonet (Miniature)
Bulb Type	Tubular	Tubular	Small Round	Small Round	Large Round	Large Round
Lamp Numbers	40 41 42 46 48	43 44 45 47 49 1490	50	51	55	1458

Lamp No.	Bead Color	Base (Miniature)	Bulb Type	RATING		Used for
				Volts	Amps.	
40	Brown	Screw	T-3 1/4	6-8	0.15	Dials
41	White	Screw	T-3 1/4	2.5	0.5	Dials
42	Green	Screw	T-3 1/4	3.2	‡	Dials
43	White	Bayonet	T-3 1/4	2.5	0.5	Dials and Tuning Meters
44	Blue	Bayonet	T-3 1/4	6-8	0.25	Dials and Tuning Meters
45	*	Bayonet	T-3 1/4	3.2	‡	Dials
46 <sup>A</sup>	Blue	Screw	T-3 1/4	6-8	0.25	Dials and Tuning Meters
47	Brown	Bayonet	T-3 1/4	6-9	0.15	Dials
48	Pink	Screw	T-3 1/4	2.0	0.06	Battery Set Dials
49	Pink	Bayonet	T-3 1/4	2.0	0.06	Battery Set Dials
50	White	Screw	G-3 1/2	6-8	0.2	Auto-Radio Dials; Flashlights
51 <sup>A</sup>	White	Bayonet	G-3 1/2	6-8	0.2	Auto-Radio Dials; Panel Boards
55	White	Bayonet	G-4 1/2	6-8	0.4	Auto-Radio Dials; Parking Lights
1458		Bayonet	G-5	20.0	0.25	Dials
1490		Bayonet	T-3 1/4	3.2	0.15	Dials

\* White in G.E. and Sylvania; Green in National Union Raytheon and Tung-Sol.

‡ 0.35 in G.E. and Sylvania; 0.5 in National Union Raytheon and Tung-Sol.

<sup>A</sup> Have frosted bulb.

## Directly Interchangeable Tubes

Tube Number	Replace with	Tube Number	Replace with	Tube Number	Replace with		
01A	40	1LN5	1LC5	5AX4	{ 5AZ4 5U4 5V4 5W4 5Y3 5Z4		
0A2	0B2	1N5	{ 1P5				
0A3	VR75		{ 1D5				
0A4	1267	1P5	{ 1N5				
0B3	VR90		{ 1D5				
0C3	VR105	1Q5	1C5				
0D3	VR150	1S6	1T6				
0Y4	0Y4G	1T4	{ 1L4				
0Z4	{ CK1005		{ 1U4				
	{ 1003	1T5	{ 1A5				
	{ 0Z4A		{ 1G4				
1A4	{ 1B4	1T6	1S6	5AZ4	{ 5AX4 5U4 5V4 5W4 5Y3 5Z4		
	{ 32	1U4	{ 1L4				
	{ 34		{ 1T4				
	{ 1A4P	1V	6Z3				
1A5	1G4	1V5	{ 1AC5	5T4	{ 5AX4 5AZ4 5U4 5V4 5W4 5Y3 5Z4		
	1A7		1D7			{ 1W5	
1AC5	1V5	1W5	1V5				
1AD5	1W5	2A3	45				
	{ 1A4	2A7	2A7S				
1B4	{ 32	2B7S	2B7			5U4	{ 5AX4 5AZ4 5T4 5V4 5W4 5Z4
	{ 34	2C52	{ 12SN7				
	1B8		{ 12SX7				
1C5	1Q5	2E5	2G5				
1C8	1E8	2E30	5812			5V4	{ 5W4 5Z4
1D5	1E5	2E31	2E32				
1D8	1B8	2E32	2E31	5V4	{ 5AX4 5AZ4 5T4 5U4 5W4		
1E4	1G4	2E35	2E36				
1E5	1D5	2E36	2E35				
1E8	1C8	2E41	2E42				
1G4	{ 1E4	2E42	2E41				
	{ 1H4	2G5	2E5				
1G5	1J5	2G21	2G22			5W4	{ 5AX4 5AZ4
1H4	{ 1G4	2G22	2G21				
	1J5	{ 1E4	3B5			{ 3C5	
1G5		{ 3Q5					
1L4	{ 1T4	3B7	1291	5W4	{ 5T4 5U4 5V4 5Z4		
	{ 1U4	3C5	{ 3B5				
1LA4	1LB4		3LE4	{ 3Q5			
1LA6	1LC6	3LF4		5X3	{ 5Z3 80 83		
1LB4	1LA4	3Q4	3S4				
1LC5	{ 1LG5	3Q5	{ 3B5				
	{ 1LN5		{ 3C5				
1LC6	1LA6	3S4	3Q4	5X4	5Y4		
1LG5	1LC5						



Directly Interchangeable Tubes—(Continued)

Tube Number	Replace with	Tube Number	Replace with	Tube Number	Replace with		
5Y3	{	5AX4	{	6AJ5	{	6C6	
		5AZ4		6AJ7		6AB7	6D6
		5T4		6AK5		6AC7	6D7
		5U4		6AK7		6AJ5	6E5
		5V4		6AL5		6AG7	6E7
		5W4				5726	6F5
5Y4	{	6AT6	{	6AV6	{	6G5	
				6BF6		6H5	
5Z3	{	6AU6	{	6BK6	{	6AD5	
				6BT6		6AE5	
				6BU6		6AF5	
5Z4	{	6AV5	{	6AG5	{	6C5	
				6BA6		6D5	
				6BD6		6E5	
				6AU5		6F5	
				6BD5		6G5	
				6AT6		6H5	
6A4	52	6AX4	{	6U4	6D5		
6A8	6J8		{	6W4	6C5		
6AB7	{	6B5	{	42	{	1233, 6K7	
				6B6		6Q7	6U7
6AC5G	{	6BA6	{	6AU6	{	6A8	
				6BD6		6K8	
6AC7	{	6BC5	{	6AG5	{	6AD4	
				6BC5		6K7	
6AD4	{	6BE6	{	6CB6	{	6A8	
				6AG5		6J8	
				6AU6		6L4	
6AD5	{	6BF6	{	6CB6	{	6L6	
				5915		6L7	
				6BU6		6L7	
6AD6	{	6BG7	{	6BF7	{	6AD5	
				6BH6		6AE5	
6AE5	{	6BJ6	{	6BJ6	{	6AF5	
				6BH6		6C5	
				6AT6		6J5	
6AF5	{	6BK6	{	6AV6	{	6J5	
				6BF6		6Q7	
				6BT6		6R7	
				6BU6		6V7	
6AF6	{	6BT6	{	6BK6	{	6SA7	
				6BU6		6S7	
6AG5	{	6C4	{	9002	{	6SB7Y	
				6AD5		6SA7	
				6AE5		6SE7	
				6AF5		6S17	
		6C5	{	6D5	{	6SK7	
						5693	

Directly Interchangeable Tubes—(Continued)

Tube Number	Replace with	Tube Number	Replace with	Tube Number	Replace with
6SE7	{ 6SD7 6SJ7 6SK7 5613	7AH7	7AG7	12AY7	12AX7
6SF7	6SV7	7AJ7	7H7	12AZ7	12AV7
6SH7	{ 6SG7 6SJ7 6SK7	7B4	7A4	12B7	14A7
6SJ7	6SK7, 5693	7B6	7E6	12BA6	{ 12AU6 12BD6
6SK7	{ 6SG7 6SH7 6SJ7	7B7	{ 7C7 7AH7	12BD6	{ 12AU6 12BA6
6SL7	{ 6SU7 5691, 5692	7B8	{ 7J7 7S7	12BF6	12BU6
6SN7	{ 5692 5691	7C7	7B7		{ 12AT6 12AV6
6SQ7	6SR7	7E5	1201	12BK6	{ 12BT6 12BU6
6SR7	6SQ7	7E6	7B6		{ 12AT6 12AV6
6ST7	6SZ7	7E7	7R7	12BT6	{ 12BK6 12BU6
6SU7	6SL7	7F7	7AF7	12BU6	12BF6
6SV7	6SF7	7G7	7V7	12J7	12K7
6SZ7	6ST7	7H7	{ 7A7 7L7	12K7	12J7
6T5	{ 6E5 6U5	7J7	7B8	12K8	12A8
6U4	{ 6W4 6AX5	7L7	{ 7A7 7H7	12L8	1644
6U5	{ 6E5 6T5	7R7	7E7	12SA7	12SY7
6U7	6K7	7S7	{ 7B8 7J7	12SC7	1634
6V7	6R7	7T7	7A7, 7H7, 7V7	12SG7	{ 12SH7 12SJ7 12SK7
6W4	{ 6U4 6AX4	7V7	7T7, 7A7, 7H7		{ 12SG7 12SH7 12SK7
6W7	6S7	7Z4	7X6	12SH7	{ 12SG7 12SH7 12SK7
6X8	6U8	10	10Y	12SJ7	{ 12SG7 12SH7 12SK7
6Z3	1V	10Y	10	12SK7	{ 12SG7 12SH7 12SK7
6Z5	6Y5	12A	71A	12SN7	12SX7
7A4	7B4	12A8	12K8	12SQ7	12SR7
7A7	{ 7H7 7L7	12AT6	{ 12AV6 12BK6	12SR7	12SQ7
7AB7	1204	12AT7	12AU7	12SW7	12SR7
7AF7	7F7	12AU6	{ 12BA6 12BD6	12SX7	12SN7
7AG7	7AH7	12AU7	12AT7	12SY7	12SA7
			{ 12AT6 12BK6 12BT6 12BU6	14A7	12B7

Directly Interchangeable Tubes—(Continued)

Tube Number	Replace with	Tube Number	Replace with	Tube Number	Replace with
14AF7	14F7	40	01A	1232	7G7
14B6	14E6	41	42	1267	0A4
14B8	{ 14J7 14S7	42	6B5	1273	7A7
		45	2A3	1274	6X5
14C7	{ 12B7 12B4	50	10	1275	{ 5X3 80 83
		50A6	50Z6		
14E6	14B6	50C6	50L6		
14E7	14R7	50Y7	50Z7	1280	14H7
14F7	14AF7	50Z6	50AX6	1284	12B7
14H7	{ 12B7 14A7	50Z7	50Y7	1291	3B7
		53	5608-A	1294	1R4
14J7	{ 14B8 14S7	55	2A6	1299	3D6
		56	27	1612	6L7
14R7	14E7	57	58	1614	6L6
14S7	{ 14J7 14B8	76	37	1620	6J7
		77	6C6	1634	12SC7
14W7	{ 12B7 14A7	78	6D6	1644	12L8
		80	{ 83 5Z3	5517	CK1003
19C8	19T8	81	50	5590	{ 9001, 5591 9003
19T8	19C8	82	{ 2A3 45		
25A6	{ 25B6 25C6 25L6 5824	83	5Z3, 80	5591	5590
		85	75	5608-A	53
		117L7	117M7	5654	{ 6AJ5 6AK5
		117N7	117P7		
25A7	32L7	950	1F4	5672	5678
25B5	43	954	956	5678	5672
25S	1B5	955	5731	5691	{ 6SN7 5692
25Y5	25Z5	956	954		
26BK6	26C6	CK1005	{ 0Y4 0Z4A	5692	{ 5691 6SN7
26C6	26BK6				
27	56	CK1013	5517	5693	6SJ7
32	{ 1A4 1B4	1201	7E5	5725	{ 6AJ5 6AK5
		1203	7C4		
32L7	25A7	1204	7AB7		
34	{ 1A4 1B4	1206	768	5731	9J5
		1221	6C6	5824	{ 25A6 25B6 25C6 25L6
1223	6J7				
36	39	1229	1A4		
37	76	1230	30		
39	36	1231	7V7	5915	6BE6

## Directly Interchangeable TV Picture Tubes

Tube Number	Replace with	Tube Number	Replace with	Tube Number	Replace with
7NP4	7WP4*	12VP4	12VP4A	16JP4	16JP4A
7WP4	7NP4	14BP4	14BP4A	16JP4	16HP4
8AP4	8AP4A	14BP4	14CP4	16JP4A	16HP4A
8AP4A	8AP4	14BP4A	14EP4	16KP4	16KP4A
10BP4	10BP4A	14CP4	14BP4	16KP4	16RP4
10BP4	10FP4		14BP4A	16KP4A	16TP4
10BP4A	10FP4A		14EP4	16LP4	16LP4A
10EP4	10CP4	14EP4	14BP4	16LP4	16ZP4
10FP4	10FP4A		14BP4A	16LP4A	
10MP4	10MP4A		14CP4	16MP4	16MP4A
10MP4A	10MP4	14FP4	14BP4*	16MP4	16HP4
12KP4	12KP4A		14BP4A*	16MP4A	16HP4A
12LP4	12LP4A		14CP4*	16QP4	16XP4
12LP4	12KP4*	15CP4	14EP4*	16RP4	16KP4
12LP4A	12KP4A*	16AP4			16KP4A
	12VP4	16AP4A	16CP4		16TP4
	12VP4A		16DP4	16SP4	16SP4A
	12TP4		16DP4	16SP4A	16SP4
12QP4	12QP4A	16DP4A	16HP4*	16SP4	16WP4A
12QP4	12JP4*		16HP4A*	16SP4A	
12QP4A	12RP4		16JP4*	16UP4	16KP4*
			16JP4A*		16KP4A*
12RP4	12JP4*		16MP4*		16RP4*
	12QP4	16EP4	16MP4A*		16TP4*
	12QP4A			16VP4	16YP4*
12TP4	12KP4**			16WP4	16SP4*
	12KP4A**	16GP4	16GP4A		16SP4A*
	12RP4*		16GP4B		16WP4A*
	12VP4*	16HP4	16HP4A		
	12VP4A*	16HP4	16JP4	16WP4A	16SP4
12UP4	12UP4A	16HP4A	16JP4A		16SP4A

\*Connect external connector to chassis.

\*Remove ion trap.

Directly Interchangeable TV Picture Tubes (Continued)

Tube Number	Replace with	Tube Number	Replace with	Tube Number	Replace with
16XP4	16QP4	17QP4	17UP4	20GP4	20JP4
16ZP4	16LP4 16LP4A	17RP4	17HP4 17HP4A 17KP4	20HP4	20HP4B 20HP4A* 20JP4* 20LP4*
17AP4	17BP4A 17BP4B 17BP4C 17JP4	17UP4	17QP4	21EP4A	21EP4B
17BP4	17AP4* 17BP4A* 17BP4B* 17BP4C* 17JP4*	17VP4	17LP4 17LP4A 17SP4	21FP4	21FP4A* 21KP4 21KP4A*
17BP4A	17BP4B 17BP4C	19AP4	19AP4A 19AP4B 19AP4C 19AP4D	21FF4A	21KP4A
17BP4A	17BP4B 17BP4C	19DP4	19DP4A	21KP4	21KP4A*
17BP4A	17AP4 17BP4B 17BP4C	19DP4A	19DP4	21WP4	20CP4A 20DP4A
17CP4	17CP4A	19EP4	19JP4	21ZP4	21ZP4A*
17CP4A	17CP4	19FP4	19DP4* 19DP4A*	22AP4	22AP4A
17FP4	17FP4A	19JP4	19EP4	22AP4A	22AP4
17FP4A	17FP4	20CP4	20CP4A 20CP4C 20DP4 20DP4A*	24AP4	24AP4A 24AP4B
17HP4	17HP4A	20CP4A	20CP4* 20DP4A	24AP4B	24AP4 24AP4A
17HP4A	17HP4	20CP4C	20CP4 20CP4A* 20DP4	27EP4	27GP4 27NP4 27RP4
17HP4	17KP4 17HP4A	20CP4C	20DP4A*	27GP4	27EP4 27NP4* 27RP4*
17JP4	17AP4 17BP4A 17BP4B 17BP4C	20DP4	20CP4 20CP4C 20CP4A* 20DP4A*	27NP4	27EP4 27GP4 27RP4
17LP4	17LP4A	20FP4	20GP4* 20JP4	27RP4	27EP4 27GP4 27NP4

\*Connect external connector to chassis.

Interchangeable Batteries

Burgess	Eveready	Neda	Ray-O-Vac	RCA	Burgess	Eveready	Neda	Ray-O-Vac	RCA
1	935-635	14	1LP	VS035	<b>B5</b>	713	8	P551	VS129
<b>1G308*</b>	W363F	716	5930C	VS127	<b>B30</b>	484	207	P5303	VS012
<b>120</b>	835		110LP		<b>C5</b>	717	9	P751	VS065
<b>17GD60</b>	759	413	AB82	VS022	<b>D3</b>	726	19	423PX	VS072
<b>2</b>	950		2LP	VS036	<b>F2BP</b>	W352	701	392S	VS100
<b>2F</b>	W353	11	192PX	VS141	<b>F3</b>	736	3	P93A	VS067
<b>2F4</b>	718	1	698P	VS010	<b>F4A50</b>	W358	411	AB327	
<b>2F4L</b>	747	16	698PL	VS011	<b>F4H</b>	409	908	941	VS040C
<b>2D</b>	720	18	122P	VS069	<b>F4PI</b>	744	6	P694A	VS009
<b>2FBP</b>	W354	700	192S	VS101	<b>F6A60</b>	753	401	AB994	VS019
<b>2R</b>	950	13	2LP*	VS036	<b>F6A60P</b>	757	406	AB909	VS058
<b>2T X X40</b>	W370	412			<b>G3</b>	746	7	P83A	VS002
<b>20F</b>	740	719	P9203	VS024	<b>G5A42</b>	W367	408	AB-794	VS038
<b>20F2</b>	X125	720	P9403	VS025	<b>G6B60</b>	752	400	AB-995	VS047
<b>21R</b>	964	20	8R	VS236	<b>G6M60</b>	754	402	AB-878	VS018
<b>210</b>	1050		3LP		<b>K45</b>	457	203	NSW45	VS082
<b>21308*</b>	W364F	715	5830C	VS157	<b>M30</b>	482	202	P7830	VS013
<b>2156</b>	766T	702	2215C	VS137	<b>N</b>		910	716	VS073
<b>220</b>	850		21DLP		<b>N60</b>	490	204	4390	VS090
<b>2308*</b>	W365F	723	5230C	VS126	<b>P45</b>	477	211P	NW45	VS218
<b>2370ST</b>	761T	712	423S	VS130	<b>P45M</b>		211M	946	VS216-15
<b>2370PI</b>	771	718	P231W	VS030	<b>P60</b>	479			
<b>4F</b>	742	4	194P	VS004	<b>S461</b>	1461	907	641	VS039
<b>4FH</b>	735	900	194S	VS106	<b>S6D60</b>	776	415	AB326	VS119
<b>4FL</b>		12	P94L	VS005	<b>T5</b>	W360	10	7C05P	
<b>4F2H</b>	W357	901	398C	VS138	<b>T5Z50</b>	755	403	AB775	VS050
<b>4F4H</b>	706	902	902	VS103	<b>T6Z60</b>	756	405	AB601	VS057W
<b>4F5H</b>	715	903	903	VS139	<b>T6Z60P</b>	756P	428		VS059
<b>4F6H</b>	716	904	904	VS140	<b>U10</b>	411	208	510P	VS083
<b>4GA42</b>	W366	407	AB944	VS053	<b>U15</b>	412	215	215	VS084
<b>4SD60</b>	758	414	AB85	VS021	<b>U15PF</b>	412		915	
<b>4TZ60</b>	729	425	AB333	VS064	<b>U20</b>	413	210	520P	VS085
<b>4156</b>	763	710	2415S	VS102	<b>U200</b>	493	722	5200	VS093
<b>422</b>	750	704	342	VS134	<b>U30</b>	415	213	530CUH	VS086
<b>432</b>	751	705	443	VS142	<b>W20PI</b>			99917	
<b>5158SC</b>	778	708	2515C	VS131	<b>W30PI</b>	733		N30P	
<b>5156PI</b>	768	721	2515P	VS031	<b>XX15</b>	425P		PN15	
<b>5308</b>	W376	709	5530S	VS112	<b>XX22</b>	433P		PN22	
<b>532</b>	703	706	453	VS133	<b>XX30</b>	455	201	930	VS055
<b>5360</b>	781	714	531R	VS028	<b>XX30PI</b>	455P		PN30F	
<b>5540</b>	773	713	755S	VS029	<b>XX45</b>	467	200	4367	VS016
<b>6F</b>	743	5	196P	VS007	<b>XX50</b>	437	212	4375	VS217
<b>6 Ign.</b>	6 Ign.	905	6 Ign.-S	VS0065	<b>XX69</b>	W361		103SN69	
<b>6 Ind.</b>	6 Ind.	911	6 RR		<b>Y10</b>	504		10P	
<b>6 Tel.</b>	6GL	906	6 Tel.-C	VS042C	<b>Y15</b>	505		515P	
<b>6TA60</b>	W369	410	AB64	VS054	<b>Y20</b>	506		20P	
<b>7</b>	912	24	400		<b>Y20S</b>	507			
<b>8F</b>	741	17	198P		<b>Z</b>	915	15	7R	VS034
<b>8R</b>	960P	23	191P	VS070	<b>Z30</b>	738	205	57R30P	VS015
<b>9R</b>	1015E		41		<b>Z30NX</b>	W350	711	57R30S	VS114
<b>920</b>	815		710LP		<b>Z4</b>	724	2	67R4	VS068
<b>A30</b>	W359	206	P430	VS014					

\* Available with plug-in terminal also.

Interchangeable Batteries—(Continued)

Eveready	Burgess	Neda	Ray-O-Vac	RCA	Eveready	Burgess	Neda	Ray-O-Vac	RCA
<b>6GL</b>	6 Tel.	906	6 Tel.-C	VS042C	<b>716</b>	4F6H	904	904	VS140
<b>6 Ign.</b>	6 Ign.	905	6 Ign.-S	VS006S	<b>717</b>	C5	9	P751	VS065
<b>6 Ind.</b>	6 Ind.	911	6RR		<b>718</b>	2F4	1	698P	VS010
<b>X-125</b>	20F2	720	P9403	VS025	<b>720</b>	2D	18	122P	VS069
<b>W-350</b>	Z30NX	711	57R30S	VS114	<b>724</b>	Z4	2	67R4	VS068
<b>W-351</b>	Z30BP				<b>726</b>	D3	19	423PX	VS072
<b>W-352</b>	F2BP	701	392S	VS100	<b>729</b>	4TZ60	425	AB333	VS064
<b>W-354</b>	2FBP	700	192S	VS101	<b>735</b>	4FH	900	194S	VS106
<b>W-355</b>	2BBP				<b>736</b>	F3	3	P93A	VS067
<b>W-356</b>	2F2H			VS136	<b>738</b>	Z30	205	57R30P	VS015
<b>W-357</b>	4F2H	901	398C	VS138	<b>740</b>	20F	719	P9203	VS024
<b>W-358</b>	W30BPX				<b>741</b>	8F	17	198P	
<b>W-362</b>	W5BP				<b>742</b>	4F	4	194P	VS004
<b>W-363F</b>	10308SC	716	5930C	VS127	<b>743</b>	6F	5	196P	VS007
<b>W-363P</b>	10308PI			VS027	<b>744</b>	F4PI	6	P694A	VS009
<b>W-364F</b>	21308SC	715	5830C	VS157	<b>746</b>	G3	7	P83A	VS002
<b>W-364P</b>	21308PI				<b>747</b>	2F4L	16	698PL	VS011
<b>W-365F</b>	2308SC	723	5230C	VS126	<b>750</b>	422	704	342	VS134
<b>W-365P</b>	2308PI			VS026	<b>751</b>	432	705	443	VS142
<b>W-371</b>	ZZ2PI				<b>752</b>	G6B60	400	AB995	VS047
<b>W-376</b>	5308	709	5530S	VS112	<b>753</b>	F6A60	401	AB994	VS019
<b>409</b>	F4H	908	941	VS040C	<b>754</b>	G6M60	402	AB878	VS018
<b>411</b>	U10	208	510P	VS083	<b>755</b>	T5Z50	403	AB775	VS050
<b>412</b>	U15, U15PF	215	215, 915	VS084	<b>756-P</b>	T6Z60, T6Z60P	405, 428	AB601	VS057W VS059
<b>413</b>	U20	210	520P	VS085	<b>757</b>	F6A60P	406	AB909	VS058
<b>415</b>	U30	213	530CUH	VS086	<b>758</b>	4SD60	414	AB85	VS021
<b>437</b>	XX50	212	4375	VS217	<b>759</b>	76D60	413	AB82	VS022
<b>455</b>	XX30	201	930	VS055	<b>761T</b>	2370ST	712	423S	VS130
<b>457</b>	K45	203	NSW45	VS082	<b>762S</b>	5308	709	5530S	VS119
<b>467</b>	XX45	200	4367	VS016	<b>763</b>	4156	710	2415S	VS102
<b>477</b>	P45	211P	NW45	VS218	<b>766T</b>	2156	702	2215C	VS137
<b>479</b>	P60				<b>768</b>	5156PI	721	2515P	VS031
<b>482</b>	M30	202	P7830	VS013	<b>771</b>	2370PI	718	P231W	VS030
<b>484</b>	B30	207	P5303	VS012	<b>773</b>	5540	713	755S	VS029
<b>490</b>	N60	204	4390	VS090	<b>776</b>	56D60	415	AB326	VS119
<b>493</b>	U200	722	5200	VS093	<b>778</b>	5156SC	708	2515C	VS131
<b>504</b>	Y10		10P		<b>781</b>	5360	714	531R	VS028
<b>505</b>	Y15		515P		<b>912</b>	7	24	400	
<b>506</b>	Y20		20P		<b>915</b>	Z	15	7R	VS034
<b>507</b>	Y20S				<b>935</b>	1	14	1LP	VS035
<b>635</b>	1	14	1LP	VS035	<b>950</b>	2, 2R	13	2LP	VS036
<b>703</b>	532	706	453	VS133	<b>960-P</b>	8R	23	191P	VS070
<b>706</b>	4F4H	902	902	VS103	<b>964</b>	21R	20	8R	VS236
<b>713</b>	B5	8	P551	VS129	<b>1461</b>	S461	907	641	VS039
<b>715</b>	4F5H	903	903	VS139					

## Resistor Color Code

RETMA STANDARD REC-116

MILITARY STANDARD MIL-R-11A

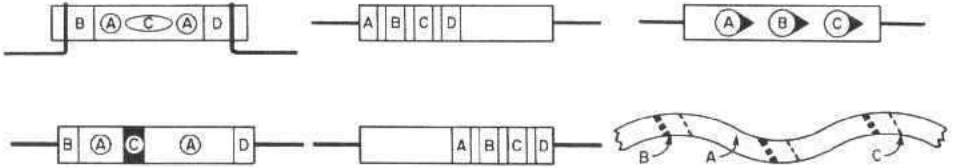

Color	1st Digit A	2nd Digit B	Multiplier C	Tolerance D
Black	0	0	1	—
Brown	1	1	10	—
Red	2	2	100	—
Orange	3	3	1,000	—
Yellow	4	4	10,000	—
Green	5	5	100,000	—
Blue	6	6	1,000,000	—
Violet	7	7	10,000,000	—
Gray	8	8	100,000,000	—
White	9	9	—	—
Gold	—	—	0.1	± 5%
Silver	—	—	0.01*	± 10%
No Color	—	—	*RETMA ONLY. —	± 20%

### INSULATION CODING

**RETMA:** Insulated resistors with axial leads are designated by a background of any color except black. The usual color is natural tan. Noninsulated resistors with axial leads are designated by a black background color.

**MILITARY (MIL):** Same as RETMA with the addition of: Noninsulated resistors with radial leads designated by a black background color or by a background the same color as the first significant figure of the resistance value.

## Mica Capacitor Color Code

### MILITARY STANDARD MIL-C-5A

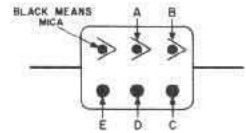

Color	Digits of Capacitance ( $\mu\text{f}$ )		Multiplier C	Tolerance D	Characteristic. See table below E
	A	B			
Black	0	0	1	± 20	—
Brown	1	1	10	—	B
Red	2	2	100	± 2	C
Orange	3	3	1,000	—	D
Yellow	4	4	—	—	E
Green	5	5	—	—	F
Blue	6	6	—	—	—
Violet	7	7	—	—	—
Gray	8	8	—	—	—
White	9	9	—	—	—
Gold	—	—	0.1	± 5	—
Silver	—	—	0.01	± 10	—

### DESCRIPTION OF CHARACTERISTIC

Characteristic	Temperature Coefficient (parts per million per °C)	Maximum Capacitance Drift	Minimum Insulation Resistance (megohms)
B	Not specified	Not specified	7500
C	±200	±0.5%	7500
D	±100	±0.3%	7500
E	+100 -20	±(0.1% -0.1 $\mu\text{f}$ )	7500
F	+70	±(0.05% +0.1 $\mu\text{f}$ )	7500

### VOLTAGE RATING

(Indicated by dimensions rather than color coding)

Maximum Inches			Style CM	Capacitance ( $\mu\text{f}$ )	Rating (v d-c)
Long	Wide	Thick			
$\frac{3}{64}$	$\frac{1}{16}$	$\frac{1}{32}$	15	5-510	300
$\frac{5}{64}$	$\frac{1}{16}$	$\frac{1}{32}$	20	5-510 560-1000	500 300
$1\frac{1}{64}$	$\frac{1}{16}$	$\frac{1}{32}$	25	51-1000	500
$\frac{33}{64}$	$\frac{5}{64}$	$\frac{1}{32}$	30	560-3300	500
$\frac{33}{64}$	$\frac{5}{64}$	$\frac{11}{32}$	35	3600-6200 6800-10,000	500 300
$1\frac{1}{32}$	$\frac{4}{64}$	$\frac{11}{32}$	40	3300-8200 9100-10,000	500 300



## Mica Capacitor Color Code RETMA STANDARD REC-115A

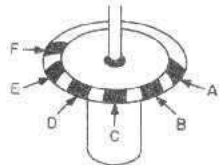
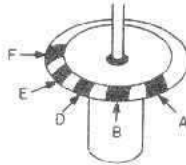
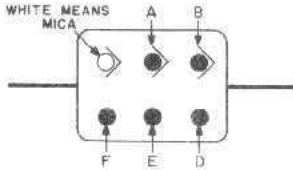

Color	Digits of Capacitance ( $\mu\mu\text{f}$ )			Multiplier D	Tolerance % E	Characteristic— See table below F
	A	B	C			
Black	0	0	0	1	—	A
Brown	1	1	1	10	$\pm 20$	B
Red	2	2	2	100	$\pm 2$	C
Orange	3	3	3	1,000	$\pm 3$	D
Yellow	4	4	4	10,000	—	E
Green	5	5	5	—	$\pm 5$	—
Blue	6	6	6	—	—	—
Violet	7	7	7	—	—	—
Gray	8	8	8	—	—	I
White	9	9	9	—	—	J
Gold	—	—	—	0.1	—	—
Silver	—	—	—	0.01	$\pm 10$	—

### DESCRIPTION OF CHARACTERISTIC

Characteristic	Temperature Coefficient (parts per million per $^{\circ}\text{C}$ )	Maximum Capacitance Drift	Minimum Insulation Resistance (megohms)
A	$\pm 1000$	$\pm (5\% + 1 \mu\mu\text{f})$	3000
B	$\pm 500$	$\pm (3\% + 1 \mu\mu\text{f})$	6000
C	$\pm 200$	$\pm (0.5\% + 0.5 \mu\mu\text{f})$	6000
D	$\pm 100$	$\pm (0.35\% + 0.1 \mu\mu\text{f})$	6000
E	+100 -20	$\pm (0.1\% + 0.1 \mu\mu\text{f})$	6000
I	+150 -50	$\pm (0.3\% + 0.2 \mu\mu\text{f})$	6000
J	+100 -50	$\pm (0.2\% + 0.2 \mu\mu\text{f})$	6000

### VOLTAGE RATING

(Indicated by dimensions rather than color coding)

Maximum Inches			Style	Capacitance ( $\mu\mu\text{f}$ )	Rating (v d-c)
Long	Wide	Thick			
$5\frac{1}{64}$	$3\frac{1}{32}$	$7\frac{1}{32}$	20	5-510 500-1000	500 300
$1\frac{1}{4}$	$3\frac{1}{32}$	$7\frac{1}{32}$	25	5-1000 1100-1500	500 300
$5\frac{5}{64}$	$3\frac{1}{64}$	$9\frac{1}{32}$	30	470-6200 Over 6200	500 300
$5\frac{5}{64}$	$5\frac{5}{64}$	$7\frac{1}{8}$	35	3300-6200 Over 6200	500 300
$1\frac{1}{32}$	$4\frac{1}{64}$	$11\frac{1}{32}$	40	100-2400 2700-7500 Over 7500	1000 500 300

## Mica Capacitor Color Code Obsolete Style

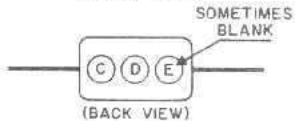
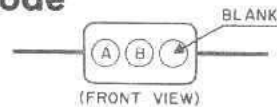
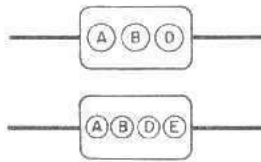
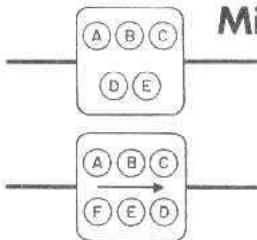

Dot Color	Digits of Capacitance ( $\mu\mu\text{f}$ )			Multiplier D	Tolerance % E	Voltage Rating (v d-c) F
	A	B	C			
Black	0	0	0	1	$\pm 20$	—
Brown	1	1	1	10	$\pm 1$	100
Red	2	2	2	100	$\pm 2$	200
Orange	3	3	3	1,000	$\pm 3$	300
Yellow	4	4	4	10,000	$\pm 4$	400
Green	5	5	5	100,000	$\pm 5$	500
Blue	6	6	6	1,000,000	$\pm 6$	600
Violet	7	7	7	10,000,000	$\pm 7$	700
Gray	8	8	8	100,000,000	$\pm 8$	800
White	9	9	9	1,000,000,000	$\pm 9$	900
Gold	—	—	—	0.1	$\pm 5$	1,000
Silver	—	—	—	0.01	$\pm 10$	2,000
No Color	—	—	—	—	$\pm 20$	500

## Ceramic Capacitor Color Code

**RETMA STANDARD REC-107A**  
**MILITARY STANDARD JAN-C-20A**  
 Proposed Mil-C-20A

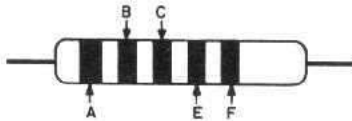

**Tubular Capacitors**  
 (Voltage rating is always 500 v.)

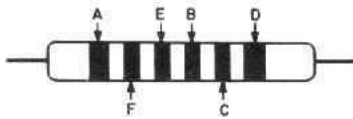

**Tubular Capacitors**  
 (Old RMA)

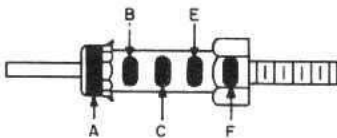

**Stand-Off Capacitors**  
 (RETMA ONLY)

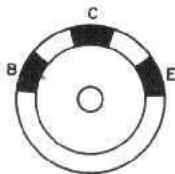

**3-Dot Button Capacitors**  
 RETMA ONLY

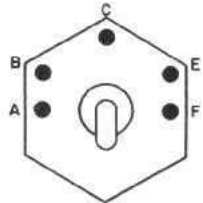

**Feed Through Capacitors**  
 (RETMA ONLY)

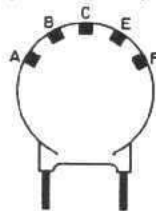

**5-Dot Disc Capacitors**  
 (RETMA ONLY)  
 (Voltage rating is always 500 v.)

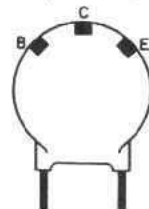

**3-Dot Disc Capacitors**  
 (RETMA ONLY)  
 (Voltage rating is always 500 v., tolerance is always -0.)

Color	Digits of Capacitance ( $\mu\mu\text{f}$ )			Multiplier E	Tolerance F		Temp. Coef. A (Parts per million per °C.)	
	B	C	D		10 $\mu\mu\text{f}$ or less ( $\mu\mu\text{f}$ )	Over 10 $\mu\mu\text{f}$ (%)	RETMA	MILITARY
Black	0	0	0	1	$\pm 2.0$	$\pm 20^*$	0	0
Brown	1	1	1	10	$\pm 0.1^*$	$\pm 1$	- 33	- 30
Red	2	2	2	100	—	$\pm 2$	- 75	- 80
Orange	3	3	3	1,000	—	$\pm 2.5^*$	- 150	- 150
Yellow	4	4	4	10,000*	—	—	- 220	- 220
Green	5	5	5	—	$\pm 0.5$	$\pm 5$	- 330	- 330
Blue	6	6	6	—	—	—	- 470	- 470
Violet	7	7	7	—	—	—	- 750	- 750
Gray	8	8	8	0.01	$\pm 0.25$	—	+ 150 to - 1500	+ 30
White	9	9	9	0.1	$\pm 1.0$	$\pm 10$	+ 100 to - 750	+ 330*
Gold	—	—	—	—	—	—	—	+ 100

\*RETMA only

## Paper Capacitor Color Code MILITARY STANDARD MIL-C-91A

(Commercial codes are same except as noted)

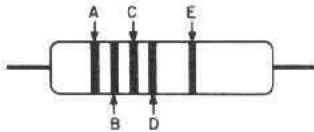

Tubular Capacitors  
(Commercial Only)

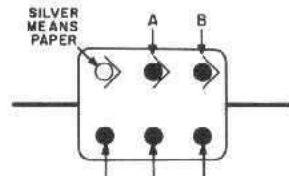

Rectangular Capacitors

Color	Digits of Capacitance ( $\mu\text{mf}$ )		Multiplier C	Tolerance % D	Tubular Voltage Rating (v d-c) E	Temp. Rating $^{\circ}\text{C}$ and Characteristic F
	A	B				
Black	0	0	1	$\pm 20$	—	85-A
Brown	1	1	10	—	100	85-E
Red	2	2	100	—	200	—
Orange	3	3	1,000	$\pm 30$	300	—
Yellow	4	4	10,000	—	400	—
Green	5	5	—	—	500	—
Blue	6	6	—	—	600	—
Violet	7	7	—	—	700	—
Gray	8	8	—	—	800	—
White	9	9	—	—	900	—
Gold	—	—	—	—	1,000	—
Silver	—	—	—	$\pm 10$	—	—

### VOLTAGE RATING FOR RECTANGULAR CAPACITORS

(Indicated by dimensions rather than color coding)

Maximum Dimensions (inches)			Style CN	Capacitance ( $\mu\text{mf}$ )	Voltage Rating (v d-c)
Length	Width	Thick- ness			
$5\frac{1}{64}$	$1\frac{1}{32}$	$7\frac{1}{32}$	20	1000	400
				2000-6000	200
				10,000	120
$7\frac{1}{64}$	$3\frac{1}{64}$	$1\frac{1}{64}$	22	2000-3000	400
				6000-10,000	300
				20,000	120
$5\frac{3}{64}$	$5\frac{3}{64}$	$9\frac{1}{32}$	30	1000-2000	800
				3000	600
				6000-10,000	400
				20,000	120
$5\frac{3}{64}$	$5\frac{3}{64}$	$1\frac{1}{32}$	35	3000	800
				6000-10,000	600
				20,000	300
$1\frac{1}{4}$	$4\frac{1}{64}$	$9\frac{1}{32}$	41	3000-6000	600
				10,000	400
				20,000	300
				30,000	120
$1\frac{11}{32}$	$4\frac{1}{64}$	$1\frac{1}{16}$	42	1000-6000	1000
				10,000-20,000	600
				30,000	400
				50,000	300
				100,000	120
$1\frac{11}{32}$	$4\frac{1}{64}$	$1\frac{1}{32}$	43	10,000	1000
				20,000-30,000	600
				50,000-100,000	400
				200,000	120

## RETMA Color Codes

The color codes on the preceding and two following pages are used by most radio and instrument manufacturers in the wiring of their products, and by parts manufacturers for identifying lead placement or resistor and capacitor values, ratings, and tolerances. These have been included for whatever help they may provide in identifying parts and

leads when trouble-shooting. Since all manufacturers do not use these codes, however, due caution must be observed to determine whether or not the set, instrument, or part under examination does or does not follow the code colors given here. A quick check with a voltmeter, ohmmeter, or continuity meter is usually all that is needed to establish this fact.

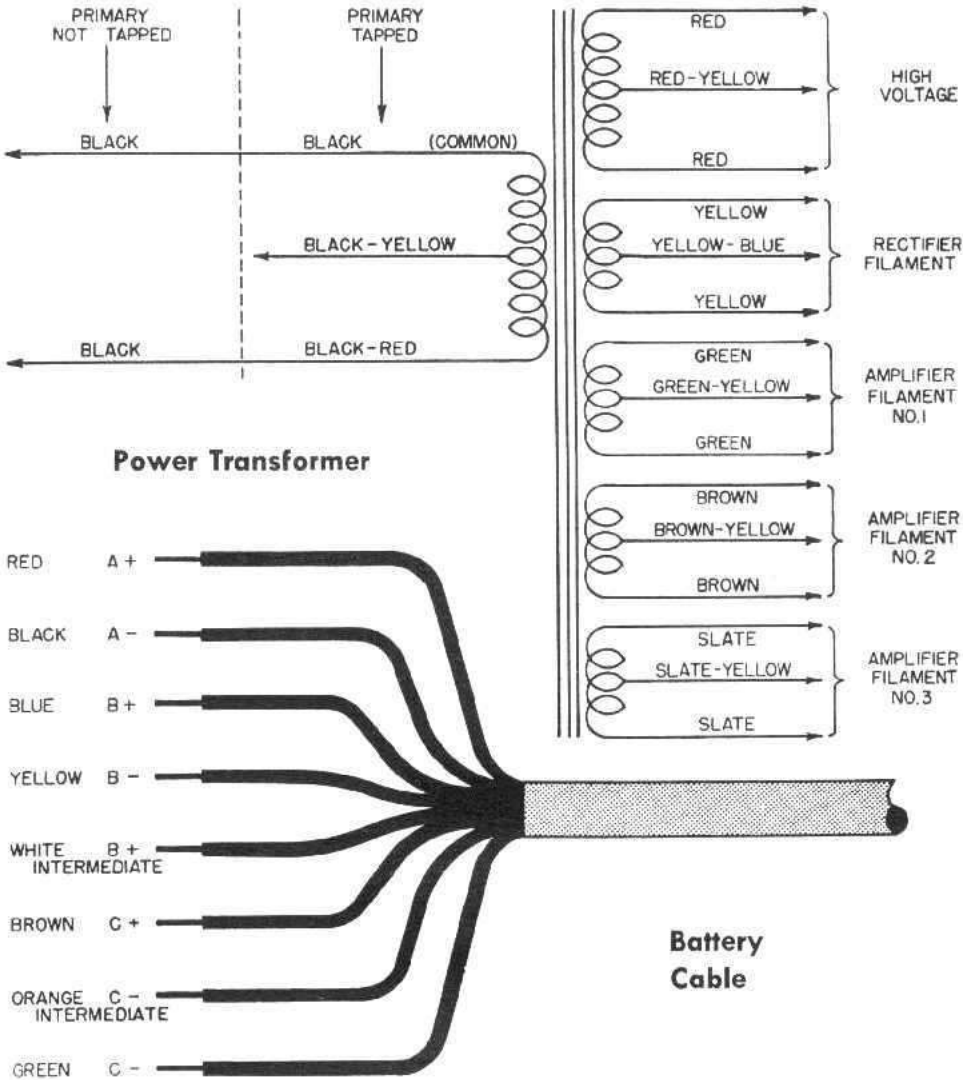

RETMA Color Codes—(Continued)

Speaker Leads and Plug Connections

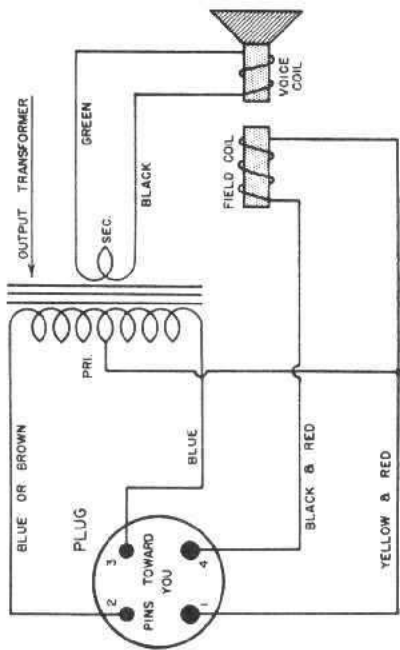
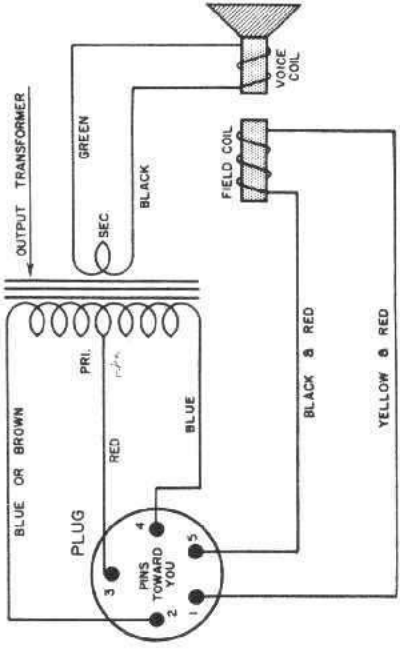

Speaker Leads and Plug Connections

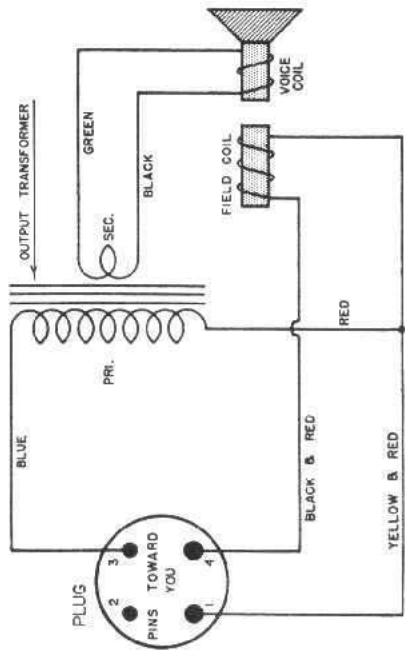
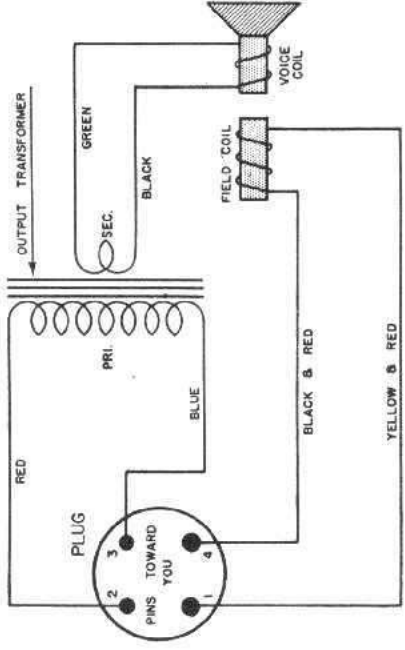

**Speaker Lead Color Codes—(Continued)**

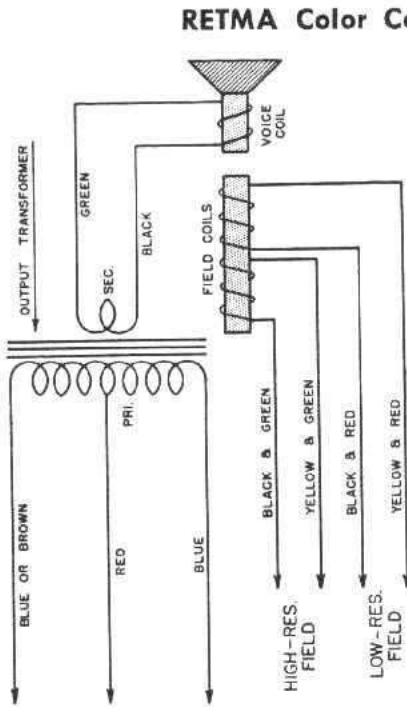
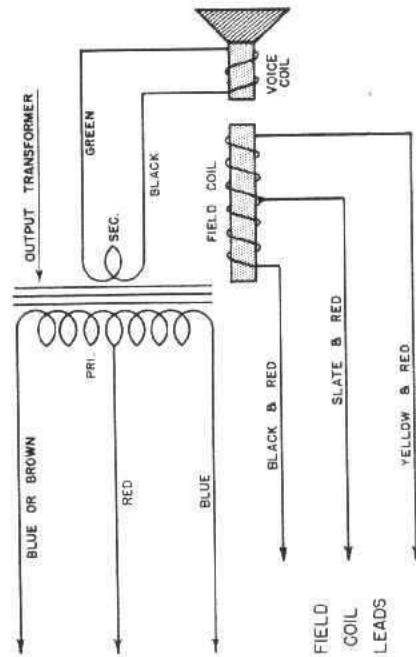

**RETMA Color Codes—(Continued)**

**I-F Transformers**

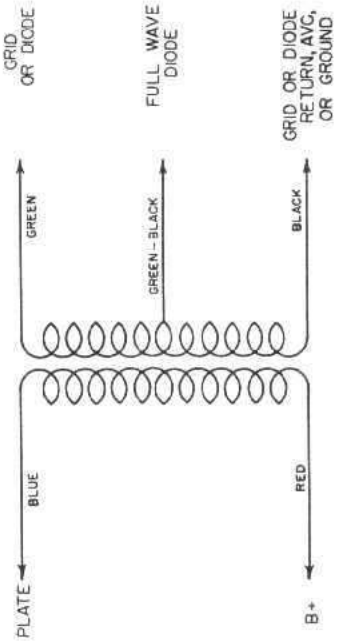



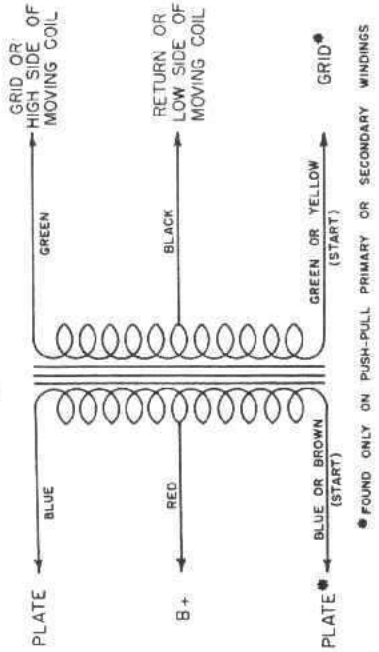





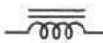
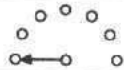

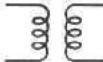





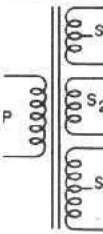











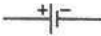





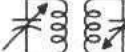



**Audio & Output Transformers**

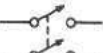

● FOUND ONLY ON PUSH-PULL PRIMARY OR SECONDARY WINDINGS

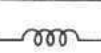
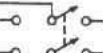
## Schematic Symbols Used in Radio Diagrams

	ANTENNA (AERIAL)		IRON CORE CHOKE COIL		SWITCH (ROTARY OR SELECTOR)
	GROUND		R.F. TRANSFORMER (AIR CORE)		CRYSTAL DETECTOR
	ANTENNA (LOOP)		A.F. TRANSFORMER (IRON CORE)		LIGHTNING ARRESTER
	WIRING METHOD 1 CONNECTION	 <p>POWER TRANSFORMER P - 115 VOLT PRIMARY S<sub>1</sub> - CENTER-TAPPED SECONDARY FOR FILAMENTS OF SIGNAL CIRCUIT TUBES S<sub>2</sub> - SECONDARY FOR RECTIFIER TUBE FILAMENT S<sub>3</sub> - CENTER-TAPPED HIGH-VOLTAGE SECONDARY.</p>		FUSE	
	NO CONNECTION			PILOT LAMP	
	WIRING METHOD 2 CONNECTION	 <p>FIXED CAPACITOR (MICA OR PAPER)</p>		HEADPHONES	
	NO CONNECTION			LOUDSPEAKER, P. M. DYNAMIC	
	TERMINAL		FIXED CAPACITOR (ELECTROLYTIC)		LOUDSPEAKER, ELECTRODYNAMIC
	ONE CELL OR "A" BATTERY		ADJUSTABLE OR VARIABLE CAPACITOR		PHONO PICK-UP
	MULTI-CELL OR "B" BATTERY		ADJUSTABLE OR VARIABLE CAPACITORS (GANGED)		VACUUM TUBE HEATER OR FILAMENT
	RESISTOR		I. F. TRANSFORMER (DOUBLE-TUNED)		VACUUM TUBE CATHODE
	POTENTIOMETER (VOLUME CONTROL)		POWER SWITCH S. P. S. T.		VACUUM TUBE GRID
	TAPPED RESISTOR OR VOLTAGE DIVIDER		SWITCH S. P. D. T.		VACUUM TUBE PLATE
	RHEOSTAT		SWITCH D. P. S. T.		3-ELEMENT VACUUM TUBE (TRIODE)
	AIR CORE CHOKE COIL		SWITCH D. P. D. T.		ALIGNING KEY OCTAL BASE TUBE

## Abbreviations and Letter Symbols

Many of the abbreviations given are in lower-case letters. Obviously, however, there will be occasions such as when the abbreviations are used in titles where the original word would have been capitalized. In these cases, the abbreviation should be similarly capitalized.

A two-word adjective expression should contain a hyphen.

<i>Term</i>	<i>Abbreviation</i>	<i>Term</i>	<i>Abbreviation</i>
Admittance.....	<i>Y</i>	Low-frequency (adjective).....	<i>l-f</i>
Alternating-current (adjective).....	<i>a-c</i>	Low frequency (noun).....	<i>l.f.</i>
Alternating current (noun).....	<i>a.c.</i>	Magnetic field intensity.....	<i>H</i>
Ampere.....	<i>a</i>	Megacycle.....	<i>Mc</i>
Angular velocity ( $2\pi f$ ).....	$\omega$	Megohm.....	<i>M<math>\Omega</math></i>
Antenna.....	<i>ant.</i>	Meter.....	<i>m</i>
Audio-frequency (adjective).....	<i>a-f</i>	Microampere.....	$\mu a$
Audio frequency (noun).....	<i>a.f.</i>	Microfarad (mfd).....	$\mu f$
Automatic volume control.....	<i>a.v.c.</i>	Microhenry.....	$\mu h$
Automatic volume expansion.....	<i>a.v.e.</i>	Micromicrofarad (mmfd).....	$\mu\mu f$
Capacitance.....	<i>C</i>	Microvolt.....	$\mu v$
Capacitive reactance.....	<i>X<sub>C</sub></i>	Microvolt per meter.....	$\mu v/m$
Centimeter.....	<i>cm</i>	Microwatt.....	$\mu w$
Conductance.....	<i>G</i>	Milliampere.....	<i>ma</i>
Continuous waves.....	<i>c.w.</i>	Millihenry.....	<i>mh</i>
Current.....	<i>I, i</i>	Millivolt.....	<i>mv</i>
Cycles per second.....	$\sim$	Millivolt per meter.....	<i>mv/m</i>
Decibel.....	<i>db</i>	Milliwatt.....	<i>mw</i>
Direct-current (adjective).....	<i>d-c</i>	Modulated continuous waves.....	<i>m.c.w.</i>
Direct current (noun).....	<i>d.c.</i>	Mutual inductance.....	<i>M</i>
Double cotton covered.....	<i>d.c.c.</i>	Ohm.....	$\Omega$
Double pole, double throw.....	<i>d.p.d.t.</i>	Power.....	<i>P</i>
Double pole, single throw.....	<i>d.p.s.t.</i>	Power factor.....	<i>p.f.</i>
Double silk covered.....	<i>d.s.c.</i>	Radio-frequency (adjective).....	<i>r-f</i>
Electric field intensity.....	<i>E</i>	Radio frequency (noun).....	<i>r.f.</i>
Electromotive force.....	<i>e.m.f.</i>	Reactance.....	<i>X</i>
Frequency.....	<i>f</i>	Resistance.....	<i>R</i>
Frequency modulation.....	<i>f.m.</i>	Revolutions per minute.....	<i>r.p.m.</i>
Ground.....	<i>gnd.</i>	Root mean square.....	<i>r.m.s.</i>
Henry.....	<i>h</i>	Self-inductance.....	<i>L</i>
High-frequency (adjective).....	<i>h-f</i>	Short wave.....	<i>s.w.</i>
High frequency (noun).....	<i>h.f.</i>	Single cotton covered.....	<i>s.c.c.</i>
Impedance.....	<i>Z</i>	Single cotton enamel.....	<i>s.c.e.</i>
Inductance.....	<i>L</i>	Single pole, double throw.....	<i>s.p.d.t.</i>
Inductive reactance.....	<i>X<sub>L</sub></i>	Single pole, single throw.....	<i>s.p.s.t.</i>
Intermediate-frequency (adjective).....	<i>i-f</i>	Single silk covered.....	<i>s.s.c.</i>
Intermediate frequency (noun).....	<i>i.f.</i>	Tuned radio frequency.....	<i>t.r.f.</i>
Interrupted continuous waves.....	<i>i.c.w.</i>	Ultra high frequency.....	<i>u.h.f.</i>
Kilocycle.....	<i>kc</i>	Vacuum tube voltmeter.....	<i>v.t.v.m</i>
Kilohm.....	<i>k<math>\Omega</math></i>	Volt.....	<i>v</i>
Kilovolt.....	<i>kv</i>	Voltage.....	<i>E, e</i>
Kilovolt ampere.....	<i>kva</i>	Volt-Ohm-Milliammeter.....	<i>v.o.m.</i>
Kilowatt.....	<i>kw</i>	Watt.....	<i>w</i>



Common Logarithms

N	0	1	2	3	4	5	6	7	8	9	N
10	0000	0043	0086	0128	0170	0212	0253	0294	0334	0374	10
11	0414	0453	0492	0531	0569	0607	0645	0682	0719	0755	11
12	0792	0828	0864	0899	0934	0969	1004	1038	1072	1106	12
13	1139	1173	1206	1239	1271	1303	1335	1367	1399	1430	13
14	1461	1492	1523	1553	1584	1614	1644	1673	1703	1732	14
15	1761	1790	1818	1847	1875	1903	1931	1959	1987	2014	15
16	2041	2068	2095	2122	2148	2175	2201	2227	2253	2279	16
17	2304	2330	2355	2380	2405	2430	2455	2480	2504	2529	17
18	2553	2577	2601	2625	2648	2672	2695	2718	2742	2765	18
19	2788	2810	2833	2856	2878	2900	2923	2945	2967	2989	19
20	3010	3032	3054	3075	3096	3118	3139	3160	3181	3201	20
21	3222	3243	3263	3284	3304	3324	3345	3365	3385	3404	21
22	3424	3444	3464	3483	3502	3522	3541	3560	3579	3598	22
23	3617	3636	3655	3674	3692	3711	3729	3747	3766	3784	23
24	3802	3820	3838	3856	3874	3892	3909	3927	3945	3962	24
25	3979	3997	4014	4031	4048	4065	4082	4099	4116	4133	25
26	4150	4166	4183	4200	4216	4232	4249	4265	4281	4298	26
27	4314	4330	4346	4362	4378	4393	4409	4425	4440	4456	27
28	4472	4487	4502	4518	4533	4548	4564	4579	4594	4609	28
29	4624	4639	4654	4669	4683	4698	4713	4728	4742	4757	29
30	4771	4786	4800	4814	4829	4843	4857	4871	4886	4900	30
31	4914	4928	4942	4955	4969	4983	4997	5011	5024	5038	31
32	5051	5065	5079	5092	5105	5119	5132	5145	5159	5172	32
33	5185	5198	5211	5224	5237	5250	5263	5276	5289	5302	33
34	5315	5328	5340	5353	5366	5378	5391	5403	5416	5428	34
35	5441	5453	5465	5478	5490	5502	5514	5527	5539	5551	35
36	5563	5575	5587	5599	5611	5623	5635	5647	5658	5670	36
37	5682	5694	5705	5717	5729	5740	5752	5763	5775	5786	37
38	5798	5809	5821	5832	5843	5855	5866	5877	5888	5899	38
39	5911	5922	5933	5944	5955	5966	5977	5988	5999	6010	39
40	6021	6031	6042	6053	6064	6075	6085	6096	6107	6117	40
41	6128	6138	6149	6160	6170	6180	6191	6201	6212	6222	41
42	6232	6243	6253	6263	6274	6284	6294	6304	6314	6325	42
43	6335	6345	6355	6365	6375	6385	6395	6405	6415	6425	43
44	6435	6444	6454	6464	6474	6484	6493	6503	6513	6522	44
45	6532	6542	6551	6561	6571	6580	6590	6599	6609	6618	45
46	6628	6637	6646	6656	6665	6675	6684	6693	6702	6712	46
47	6721	6730	6739	6749	6758	6767	6776	6785	6794	6803	47
48	6812	6821	6830	6839	6848	6857	6866	6875	6884	6893	48
49	6902	6911	6920	6928	6937	6946	6955	6964	6972	6981	49
50	6990	6998	7007	7016	7024	7033	7042	7050	7059	7067	50
51	7076	7084	7093	7101	7110	7118	7126	7135	7143	7152	51
52	7160	7168	7177	7185	7193	7202	7210	7218	7226	7235	52
53	7243	7251	7259	7267	7275	7284	7292	7300	7308	7316	53
54	7324	7332	7340	7348	7356	7364	7372	7380	7388	7396	54
N	0	1	2	3	4	5	6	7	8	9	N

Common Logarithms (Continued)

N	0	1	2	3	4	5	6	7	8	9	N
55	7404	7412	7419	7427	7435	7443	7451	7459	7466	7474	55
56	7482	7490	7497	7505	7513	7520	7528	7536	7543	7551	56
57	7559	7566	7574	7582	7589	7597	7604	7612	7619	7627	57
58	7634	7642	7649	7657	7664	7672	7679	7686	7694	7701	58
59	7709	7716	7723	7731	7738	7745	7752	7760	7767	7774	59
60	7782	7789	7796	7803	7810	7818	7825	7832	7839	7846	60
61	7853	7860	7868	7875	7882	7889	7896	7903	7910	7917	61
62	7924	7931	7938	7945	7952	7959	7966	7973	7980	7987	62
63	7993	8000	8007	8014	8021	8028	8035	8041	8048	8055	63
64	8062	8069	8075	8082	8089	8096	8102	8109	8116	8122	64
65	8129	8136	8142	8149	8156	8162	8169	8176	8182	8189	65
66	8196	8202	8209	8215	8222	8228	8235	8241	8248	8254	66
67	8261	8267	8274	8280	8287	8293	8299	8306	8312	8319	67
68	8325	8331	8338	8344	8351	8357	8363	8370	8376	8382	68
69	8388	8395	8401	8407	8414	8420	8426	8432	8439	8445	69
70	8451	8457	8463	8470	8476	8482	8488	8494	8500	8506	70
71	8513	8519	8525	8531	8537	8543	8549	8555	8561	8567	71
72	8573	8579	8585	8591	8597	8603	8609	8615	8621	8627	72
73	8633	8639	8645	8651	8657	8663	8669	8675	8681	8686	73
74	8692	8698	8704	8710	8716	8722	8727	8733	8739	8745	74
75	8751	8756	8762	8768	8774	8779	8785	8791	8797	8802	75
76	8808	8814	8820	8825	8831	8837	8842	8848	8854	8859	76
77	8865	8871	8876	8882	8887	8893	8899	8904	8910	8915	77
78	8921	8927	8932	8938	8943	8949	8954	8960	8965	8971	78
79	8976	8982	8987	8993	8998	9004	9009	9015	9020	9025	79
80	9031	9036	9042	9047	9053	9058	9063	9069	9074	9079	80
81	9085	9090	9096	9101	9106	9112	9117	9122	9128	9133	81
82	9138	9143	9149	9154	9159	9165	9170	9175	9180	9186	82
83	9191	9196	9201	9206	9212	9217	9222	9227	9232	9238	83
84	9243	9248	9253	9258	9263	9269	9274	9279	9284	9289	84
85	9294	9299	9304	9309	9315	9320	9325	9330	9335	9340	85
86	9345	9350	9355	9360	9365	9370	9375	9380	9385	9390	86
87	9395	9400	9405	9410	9415	9420	9425	9430	9435	9440	87
88	9445	9450	9455	9460	9465	9469	9474	9479	9484	9489	88
89	9494	9499	9504	9509	9513	9518	9523	9528	9533	9538	89
90	9542	9547	9552	9557	9562	9566	9571	9576	9581	9586	90
91	9590	9595	9600	9605	9609	9614	9619	9624	9628	9633	91
92	9638	9643	9647	9652	9657	9661	9666	9671	9675	9680	92
93	9685	9689	9694	9699	9703	9708	9713	9717	9722	9727	93
94	9731	9736	9741	9745	9750	9754	9759	9763	9768	9773	94
95	9777	9782	9786	9791	9795	9800	9805	9809	9814	9818	95
96	9823	9827	9832	9836	9841	9845	9850	9854	9859	9863	96
97	9868	9872	9877	9881	9886	9890	9894	9899	9903	9908	97
98	9912	9917	9921	9926	9930	9934	9939	9943	9948	9952	98
99	9956	9961	9965	9969	9974	9978	9983	9987	9991	9996	99
N	0	1	2	3	4	5	6	7	8	9	N

Natural Sines, Cosines, and Tangents  
0°-14.9°

Degs.	Function	0.0°	0.1°	0.2°	0.3°	0.4°	0.5°	0.6°	0.7°	0.8°	0.9°
0	sin	0.0000	0.0017	0.0035	0.0052	0.0070	0.0087	0.0105	0.0122	0.0140	0.0157
	cos	1.0000	1.0000	1.0000	1.0000	1.0000	1.0000	0.9999	0.9999	0.9999	0.9999
	tan	0.0000	0.0017	0.0035	0.0052	0.0070	0.0087	0.0105	0.0122	0.0140	0.0157
1	sin	0.0175	0.0192	0.0209	0.0227	0.0244	0.0262	0.0279	0.0297	0.0314	0.0332
	cos	0.9998	0.9998	0.9998	0.9997	0.9997	0.9997	0.9996	0.9996	0.9996	0.9995
	tan	0.0175	0.0192	0.0209	0.0227	0.0244	0.0262	0.0279	0.0297	0.0314	0.0332
2	sin	0.0349	0.0366	0.0384	0.0401	0.0419	0.0436	0.0454	0.0471	0.0488	0.0506
	cos	0.9994	0.9993	0.9993	0.9992	0.9991	0.9990	0.9990	0.9989	0.9988	0.9987
	tan	0.0349	0.0367	0.0384	0.0402	0.0419	0.0437	0.0454	0.0472	0.0489	0.0507
3	sin	0.0523	0.0541	0.0558	0.0576	0.0593	0.0610	0.0628	0.0645	0.0663	0.0680
	cos	0.9986	0.9985	0.9984	0.9983	0.9982	0.9981	0.9980	0.9979	0.9978	0.9977
	tan	0.0524	0.0542	0.0559	0.0577	0.0594	0.0612	0.0629	0.0647	0.0664	0.0682
4	sin	0.0698	0.0715	0.0732	0.0750	0.0767	0.0785	0.0802	0.0819	0.0837	0.0854
	cos	0.9976	0.9974	0.9973	0.9972	0.9971	0.9969	0.9968	0.9966	0.9965	0.9963
	tan	0.0699	0.0717	0.0734	0.0752	0.0769	0.0787	0.0805	0.0822	0.0840	0.0857
5	sin	0.0872	0.0889	0.0906	0.0924	0.0941	0.0958	0.0976	0.0993	0.1011	0.1028
	cos	0.9962	0.9960	0.9959	0.9957	0.9956	0.9954	0.9952	0.9951	0.9949	0.9947
	tan	0.0875	0.0892	0.0910	0.0928	0.0945	0.0963	0.0981	0.0998	0.1016	0.1033
6	sin	0.1045	0.1063	0.1080	0.1097	0.1115	0.1132	0.1149	0.1167	0.1184	0.1201
	cos	0.9945	0.9943	0.9942	0.9940	0.9938	0.9936	0.9934	0.9932	0.9930	0.9928
	tan	0.1051	0.1069	0.1086	0.1104	0.1122	0.1139	0.1157	0.1175	0.1192	0.1210
7	sin	0.1219	0.1236	0.1253	0.1271	0.1288	0.1305	0.1323	0.1340	0.1357	0.1374
	cos	0.9925	0.9923	0.9921	0.9919	0.9917	0.9914	0.9912	0.9910	0.9907	0.9905
	tan	0.1228	0.1246	0.1263	0.1281	0.1299	0.1317	0.1334	0.1352	0.1370	0.1388
8	sin	0.1392	0.1409	0.1426	0.1444	0.1461	0.1478	0.1495	0.1513	0.1530	0.1547
	cos	0.9903	0.9900	0.9898	0.9895	0.9893	0.9890	0.9888	0.9885	0.9882	0.9880
	tan	0.1405	0.1423	0.1441	0.1459	0.1477	0.1495	0.1512	0.1530	0.1548	0.1566
9	sin	0.1564	0.1582	0.1599	0.1616	0.1633	0.1650	0.1668	0.1685	0.1702	0.1719
	cos	0.9877	0.9874	0.9871	0.9869	0.9866	0.9863	0.9860	0.9857	0.9854	0.9851
	tan	0.1584	0.1602	0.1620	0.1638	0.1655	0.1673	0.1691	0.1709	0.1727	0.1745
10	sin	0.1736	0.1754	0.1771	0.1788	0.1805	0.1822	0.1840	0.1857	0.1874	0.1891
	cos	0.9848	0.9845	0.9842	0.9839	0.9836	0.9833	0.9829	0.9826	0.9823	0.9820
	tan	0.1763	0.1781	0.1799	0.1817	0.1835	0.1853	0.1871	0.1890	0.1908	0.1926
11	sin	0.1908	0.1925	0.1942	0.1959	0.1977	0.1994	0.2011	0.2028	0.2045	0.2062
	cos	0.9816	0.9813	0.9810	0.9806	0.9803	0.9799	0.9796	0.9792	0.9789	0.9785
	tan	0.1944	0.1962	0.1980	0.1998	0.2016	0.2035	0.2053	0.2071	0.2089	0.2107
12	sin	0.2079	0.2096	0.2113	0.2130	0.2147	0.2164	0.2181	0.2198	0.2215	0.2232
	cos	0.9781	0.9778	0.9774	0.9770	0.9767	0.9763	0.9759	0.9755	0.9751	0.9748
	tan	0.2126	0.2144	0.2162	0.2180	0.2199	0.2217	0.2235	0.2254	0.2272	0.2290
13	sin	0.2250	0.2267	0.2284	0.2300	0.2318	0.2334	0.2351	0.2368	0.2385	0.2402
	cos	0.9744	0.9740	0.9736	0.9732	0.9728	0.9724	0.9720	0.9715	0.9711	0.9707
	tan	0.2309	0.2327	0.2345	0.2364	0.2382	0.2401	0.2419	0.2438	0.2456	0.2475
14	sin	0.2419	0.2436	0.2453	0.2470	0.2487	0.2504	0.2521	0.2538	0.2554	0.2571
	cos	0.9703	0.9699	0.9694	0.9690	0.9686	0.9681	0.9677	0.9673	0.9668	0.9664
	tan	0.2493	0.2512	0.2530	0.2549	0.2568	0.2586	0.2605	0.2623	0.2642	0.2661
Degs.	Function	0'	6'	12'	18'	24'	30'	36'	42'	48'	54'

Natural Sines, Cosines, and Tangents—(Continued)

15°-29.9°

Degs.	Function	0.0°	0.1°	0.2°	0.3°	0.4°	0.5°	0.6°	0.7°	0.8°	0.9°
15	sin	0.2588	0.2605	0.2622	0.2639	0.2656	0.2672	0.2689	0.2706	0.2723	0.2740
	cos	0.9659	0.9656	0.9650	0.9646	0.9641	0.9636	0.9632	0.9627	0.9622	0.9617
	tan	0.2679	0.2698	0.2717	0.2736	0.2754	0.2773	0.2792	0.2811	0.2830	0.2849
16	sin	0.2756	0.2773	0.2790	0.2807	0.2823	0.2840	0.2857	0.2874	0.2890	0.2907
	cos	0.9613	0.9608	0.9603	0.9598	0.9593	0.9588	0.9583	0.9578	0.9573	0.9568
	tan	0.2867	0.2886	0.2905	0.2924	0.2943	0.2962	0.2981	0.3000	0.3019	0.3038
17	sin	0.2924	0.2940	0.2957	0.2974	0.2990	0.3007	0.3024	0.3040	0.3057	0.3074
	cos	0.9563	0.9558	0.9553	0.9548	0.9542	0.9537	0.9532	0.9527	0.9521	0.9516
	tan	0.3057	0.3076	0.3096	0.3115	0.3134	0.3153	0.3172	0.3191	0.3211	0.3230
18	sin	0.3090	0.3107	0.3123	0.3140	0.3156	0.3173	0.3190	0.3206	0.3223	0.3239
	cos	0.9511	0.9505	0.9500	0.9494	0.9489	0.9483	0.9478	0.9472	0.9466	0.9461
	tan	0.3249	0.3269	0.3288	0.3307	0.3327	0.3346	0.3365	0.3385	0.3404	0.3424
19	sin	0.3256	0.3272	0.3289	0.3305	0.3322	0.3338	0.3355	0.3371	0.3387	0.3404
	cos	0.9455	0.9449	0.9444	0.9438	0.9432	0.9426	0.9421	0.9415	0.9409	0.9403
	tan	0.3443	0.3463	0.3482	0.3502	0.3522	0.3541	0.3561	0.3581	0.3600	0.3620
20	sin	0.3420	0.3437	0.3453	0.3469	0.3486	0.3502	0.3518	0.3535	0.3551	0.3567
	cos	0.9397	0.9391	0.9385	0.9379	0.9373	0.9367	0.9361	0.9354	0.9348	0.9342
	tan	0.3640	0.3659	0.3679	0.3699	0.3719	0.3739	0.3759	0.3779	0.3799	0.3819
21	sin	0.3584	0.3600	0.3616	0.3633	0.3649	0.3665	0.3681	0.3697	0.3714	0.3730
	cos	0.9336	0.9330	0.9323	0.9317	0.9311	0.9304	0.9298	0.9291	0.9285	0.9278
	tan	0.3839	0.3859	0.3879	0.3899	0.3919	0.3939	0.3959	0.3979	0.4000	0.4020
22	sin	0.3746	0.3762	0.3778	0.3795	0.3811	0.3827	0.3843	0.3859	0.3875	0.3891
	cos	0.9272	0.9265	0.9259	0.9252	0.9245	0.9239	0.9232	0.9225	0.9219	0.9212
	tan	0.4040	0.4061	0.4081	0.4101	0.4122	0.4142	0.4163	0.4183	0.4204	0.4224
23	sin	0.3907	0.3923	0.3939	0.3955	0.3971	0.3987	0.4003	0.4019	0.4035	0.4051
	cos	0.9205	0.9198	0.9191	0.9184	0.9178	0.9171	0.9164	0.9157	0.9150	0.9143
	tan	0.4245	0.4265	0.4286	0.4307	0.4327	0.4348	0.4369	0.4390	0.4411	0.4431
24	sin	0.4067	0.4083	0.4099	0.4115	0.4131	0.4147	0.4163	0.4179	0.4195	0.4210
	cos	0.9135	0.9128	0.9121	0.9114	0.9107	0.9100	0.9092	0.9085	0.9078	0.9070
	tan	0.4452	0.4473	0.4494	0.4515	0.4536	0.4557	0.4578	0.4599	0.4621	0.4642
25	sin	0.4226	0.4242	0.4258	0.4274	0.4289	0.4305	0.4321	0.4337	0.4352	0.4368
	cos	0.9063	0.9056	0.9048	0.9041	0.9033	0.9026	0.9018	0.9011	0.9003	0.8996
	tan	0.4663	0.4684	0.4706	0.4727	0.4748	0.4770	0.4791	0.4813	0.4834	0.4856
26	sin	0.4384	0.4399	0.4415	0.4431	0.4446	0.4462	0.4478	0.4493	0.4509	0.4524
	cos	0.8988	0.8980	0.8973	0.8965	0.8957	0.8949	0.8942	0.8934	0.8926	0.8918
	tan	0.4877	0.4899	0.4921	0.4942	0.4964	0.4986	0.5008	0.5029	0.5051	0.5073
27	sin	0.4540	0.4555	0.4571	0.4586	0.4602	0.4617	0.4633	0.4648	0.4664	0.4679
	cos	0.8910	0.8902	0.8894	0.8886	0.8878	0.8870	0.8862	0.8854	0.8846	0.8838
	tan	0.5095	0.5117	0.5139	0.5161	0.5184	0.5206	0.5228	0.5250	0.5272	0.5295
28	sin	0.4695	0.4710	0.4726	0.4741	0.4756	0.4772	0.4787	0.4802	0.4818	0.4833
	cos	0.8829	0.8821	0.8813	0.8805	0.8796	0.8788	0.8780	0.8771	0.8763	0.8755
	tan	0.5317	0.5340	0.5362	0.5384	0.5407	0.5430	0.5452	0.5475	0.5498	0.5520
29	sin	0.4848	0.4863	0.4879	0.4894	0.4909	0.4924	0.4939	0.4955	0.4970	0.4985
	cos	0.8746	0.8738	0.8729	0.8721	0.8712	0.8704	0.8695	0.8686	0.8678	0.8669
	tan	0.5543	0.5566	0.5589	0.5612	0.5635	0.5658	0.5681	0.5704	0.5727	0.5750
Degs.	Function	0'	6'	12'	18'	24'	30'	36'	42'	48'	54'

Natural Sines, Cosines, and Tangents—(Continued)

30°-44.9°

Degs.	Function	0.0°	0.1°	0.2°	0.3°	0.4°	0.5°	0.6°	0.7°	0.8°	0.9°
30	sin	0.5000	0.5015	0.5030	0.5045	0.5060	0.5075	0.5090	0.5105	0.5120	0.5135
	cos	0.8660	0.8652	0.8643	0.8634	0.8625	0.8616	0.8607	0.8599	0.8590	0.8581
	tan	0.5774	0.5797	0.5820	0.5844	0.5867	0.5890	0.5914	0.5938	0.5961	0.5985
31	sin	0.5150	0.5165	0.5180	0.5195	0.5210	0.5225	0.5240	0.5255	0.5270	0.5284
	cos	0.8572	0.8563	0.8554	0.8545	0.8536	0.8526	0.8517	0.8508	0.8499	0.8490
	tan	0.6009	0.6032	0.6056	0.6080	0.6104	0.6128	0.6152	0.6176	0.6200	0.6224
32	sin	0.5299	0.5314	0.5329	0.5344	0.5358	0.5373	0.5388	0.5402	0.5417	0.5432
	cos	0.8480	0.8471	0.8462	0.8453	0.8443	0.8434	0.8425	0.8415	0.8406	0.8396
	tan	0.6249	0.6273	0.6297	0.6322	0.6346	0.6371	0.6395	0.6420	0.6445	0.6469
33	sin	0.5446	0.5461	0.5476	0.5490	0.5505	0.5519	0.5534	0.5548	0.5563	0.5577
	cos	0.8387	0.8377	0.8368	0.8358	0.8348	0.8339	0.8329	0.8320	0.8310	0.8300
	tan	0.6494	0.6519	0.6544	0.6569	0.6594	0.6619	0.6644	0.6669	0.6694	0.6720
34	sin	0.5592	0.5606	0.5621	0.5635	0.5650	0.5664	0.5678	0.5693	0.5707	0.5721
	cos	0.8290	0.8281	0.8271	0.8261	0.8251	0.8241	0.8231	0.8221	0.8211	0.8202
	tan	0.6745	0.6771	0.6796	0.6822	0.6847	0.6873	0.6899	0.6924	0.6950	0.6976
35	sin	0.5736	0.5750	0.5764	0.5779	0.5793	0.5807	0.5821	0.5835	0.5850	0.5864
	cos	0.8192	0.8181	0.8171	0.8161	0.8151	0.8141	0.8131	0.8121	0.8111	0.8100
	tan	0.7002	0.7028	0.7054	0.7080	0.7107	0.7133	0.7159	0.7186	0.7212	0.7239
36	sin	0.5878	0.5892	0.5906	0.5920	0.5934	0.5948	0.5962	0.5976	0.5990	0.6004
	cos	0.8090	0.8080	0.8070	0.8059	0.8049	0.8039	0.8028	0.8018	0.8007	0.7997
	tan	0.7265	0.7292	0.7319	0.7346	0.7373	0.7400	0.7427	0.7454	0.7481	0.7508
37	sin	0.6018	0.6032	0.6046	0.6060	0.6074	0.6088	0.6101	0.6115	0.6129	0.6143
	cos	0.7986	0.7976	0.7965	0.7955	0.7944	0.7934	0.7923	0.7912	0.7902	0.7891
	tan	0.7536	0.7563	0.7590	0.7618	0.7646	0.7673	0.7701	0.7729	0.7757	0.7785
38	sin	0.6157	0.6170	0.6184	0.6198	0.6211	0.6225	0.6239	0.6252	0.6266	0.6280
	cos	0.7880	0.7869	0.7859	0.7848	0.7837	0.7826	0.7815	0.7804	0.7793	0.7782
	tan	0.7813	0.7841	0.7869	0.7898	0.7926	0.7954	0.7983	0.8012	0.8040	0.8069
39	sin	0.6293	0.6307	0.6320	0.6334	0.6347	0.6361	0.6374	0.6388	0.6401	0.6414
	cos	0.7771	0.7760	0.7749	0.7738	0.7727	0.7716	0.7705	0.7694	0.7683	0.7672
	tan	0.8098	0.8127	0.8156	0.8185	0.8214	0.8243	0.8273	0.8302	0.8332	0.8361
40	sin	0.6428	0.6441	0.6455	0.6468	0.6481	0.6494	0.6508	0.6521	0.6534	0.6547
	cos	0.7660	0.7649	0.7638	0.7627	0.7615	0.7604	0.7593	0.7581	0.7570	0.7559
	tan	0.8391	0.8421	0.8451	0.8481	0.8511	0.8541	0.8571	0.8601	0.8632	0.8662
41	sin	0.6561	0.6574	0.6587	0.6600	0.6613	0.6626	0.6639	0.6652	0.6665	0.6678
	cos	0.7547	0.7536	0.7524	0.7513	0.7501	0.7490	0.7478	0.7466	0.7455	0.7443
	tan	0.8693	0.8724	0.8754	0.8785	0.8816	0.8847	0.8878	0.8910	0.8941	0.8972
42	sin	0.6691	0.6704	0.6717	0.6730	0.6743	0.6756	0.6769	0.6782	0.6794	0.6807
	cos	0.7431	0.7420	0.7408	0.7396	0.7385	0.7373	0.7361	0.7349	0.7337	0.7325
	tan	0.9004	0.9036	0.9067	0.9099	0.9131	0.9163	0.9195	0.9228	0.9260	0.9293
43	sin	0.6820	0.6833	0.6845	0.6858	0.6871	0.6884	0.6896	0.6909	0.6921	0.6934
	cos	0.7314	0.7302	0.7290	0.7278	0.7266	0.7254	0.7242	0.7230	0.7218	0.7206
	tan	0.9325	0.9358	0.9391	0.9424	0.9457	0.9490	0.9523	0.9555	0.9590	0.9623
44	sin	0.6947	0.6959	0.6972	0.6984	0.6997	0.7009	0.7022	0.7034	0.7046	0.7059
	cos	0.7193	0.7181	0.7169	0.7157	0.7145	0.7133	0.7120	0.7108	0.7096	0.7083
	tan	0.9657	0.9691	0.9725	0.9759	0.9793	0.9827	0.9861	0.9895	0.9930	0.9965
Degs.	Function	0'	6'	12'	18'	24'	30'	36'	42'	48'	54'

Natural Sines, Cosines, and Tangents—(Continued)

45°-59.9°

Degs.	Function	0.0°	0.1°	0.2°	0.3°	0.4°	0.5°	0.6°	0.7°	0.8°	0.9°
45	sin	0.7071	0.7083	0.7096	0.7108	0.7120	0.7133	0.7145	0.7157	0.7169	0.7181
	cos	0.7071	0.7059	0.7046	0.7034	0.7022	0.7009	0.6997	0.6984	0.6972	0.6959
	tan	1.0000	1.0035	1.0070	1.0105	1.0141	1.0176	1.0212	1.0247	1.0283	1.0319
46	sin	0.7193	0.7206	0.7218	0.7230	0.7242	0.7254	0.7266	0.7278	0.7290	0.7302
	cos	0.6947	0.6934	0.6921	0.6909	0.6896	0.6884	0.6871	0.6858	0.6845	0.6833
	tan	1.0355	1.0392	1.0428	1.0464	1.0501	1.0538	1.0575	1.0612	1.0649	1.0686
47	sin	0.7314	0.7325	0.7337	0.7349	0.7361	0.7373	0.7385	0.7396	0.7408	0.7420
	cos	0.6820	0.6807	0.6794	0.6782	0.6769	0.6756	0.6743	0.6730	0.6717	0.6704
	tan	1.0724	1.0761	1.0799	1.0837	1.0875	1.0913	1.0951	1.0990	1.1028	1.1067
48	sin	0.7431	0.7443	0.7455	0.7466	0.7478	0.7490	0.7501	0.7513	0.7524	0.7536
	cos	0.6691	0.6678	0.6665	0.6652	0.6639	0.6626	0.6613	0.6600	0.6587	0.6574
	tan	1.1106	1.1145	1.1184	1.1224	1.1263	1.1303	1.1343	1.1383	1.1423	1.1463
49	sin	0.7547	0.7559	0.7570	0.7581	0.7593	0.7604	0.7615	0.7627	0.7638	0.7649
	cos	0.6561	0.6547	0.6534	0.6521	0.6508	0.6494	0.6481	0.6468	0.6455	0.6441
	tan	1.1504	1.1544	1.1585	1.1626	1.1667	1.1708	1.1750	1.1792	1.1833	1.1875
50	sin	0.7660	0.7672	0.7683	0.7694	0.7705	0.7716	0.7727	0.7738	0.7749	0.7760
	cos	0.6428	0.6414	0.6401	0.6388	0.6374	0.6361	0.6347	0.6334	0.6320	0.6307
	tan	1.1918	1.1960	1.2002	1.2045	1.2088	1.2131	1.2174	1.2218	1.2261	1.2305
51	sin	0.7771	0.7782	0.7793	0.7804	0.7815	0.7826	0.7837	0.7848	0.7859	0.7869
	cos	0.6293	0.6280	0.6266	0.6252	0.6239	0.6225	0.6211	0.6198	0.6184	0.6170
	tan	1.2349	1.2393	1.2437	1.2482	1.2527	1.2572	1.2617	1.2662	1.2708	1.2753
52	sin	0.7880	0.7891	0.7902	0.7912	0.7923	0.7934	0.7944	0.7955	0.7965	0.7976
	cos	0.6157	0.6143	0.6129	0.6115	0.6101	0.6088	0.6074	0.6060	0.6046	0.6032
	tan	1.2799	1.2846	1.2892	1.2938	1.2985	1.3032	1.3079	1.3127	1.3175	1.3222
53	sin	0.7986	0.7997	0.8007	0.8018	0.8028	0.8039	0.8049	0.8059	0.8070	0.8080
	cos	0.6018	0.6004	0.5990	0.5976	0.5962	0.5948	0.5934	0.5920	0.5906	0.5892
	tan	1.3270	1.3319	1.3367	1.3416	1.3465	1.3514	1.3564	1.3613	1.3663	1.3713
54	sin	0.8090	0.8100	0.8111	0.8121	0.8131	0.8141	0.8151	0.8161	0.8171	0.8181
	cos	0.5878	0.5864	0.5850	0.5835	0.5821	0.5807	0.5793	0.5779	0.5764	0.5750
	tan	1.3764	1.3814	1.3865	1.3916	1.3968	1.4019	1.4071	1.4124	1.4176	1.4229
55	sin	0.8192	0.8202	0.8211	0.8221	0.8231	0.8241	0.8251	0.8261	0.8271	0.8281
	cos	0.5736	0.5721	0.5707	0.5693	0.5678	0.5664	0.5650	0.5635	0.5621	0.5606
	tan	1.4281	1.4335	1.4388	1.4442	1.4496	1.4550	1.4605	1.4659	1.4715	1.4770
56	sin	0.8290	0.8300	0.8310	0.8320	0.8329	0.8339	0.8348	0.8358	0.8368	0.8377
	cos	0.5592	0.5577	0.5563	0.5548	0.5534	0.5519	0.5505	0.5490	0.5476	0.5461
	tan	1.4826	1.4882	1.4938	1.4994	1.5051	1.5108	1.5166	1.5224	1.5282	1.5340
57	sin	0.8387	0.8396	0.8405	0.8415	0.8425	0.8434	0.8443	0.8453	0.8462	0.8471
	cos	0.5446	0.5432	0.5417	0.5402	0.5388	0.5373	0.5358	0.5344	0.5329	0.5314
	tan	1.5399	1.5458	1.5517	1.5577	1.5637	1.5697	1.5757	1.5818	1.5880	1.5941
58	sin	0.8480	0.8490	0.8499	0.8508	0.8517	0.8526	0.8536	0.8545	0.8554	0.8563
	cos	0.5299	0.5284	0.5270	0.5255	0.5240	0.5225	0.5210	0.5195	0.5180	0.5165
	tan	1.6003	1.6066	1.6128	1.6191	1.6255	1.6319	1.6383	1.6447	1.6512	1.6577
59	sin	0.8572	0.8581	0.8590	0.8599	0.8607	0.8616	0.8625	0.8634	0.8643	0.8652
	cos	0.5150	0.5135	0.5120	0.5105	0.5090	0.5075	0.5060	0.5045	0.5030	0.5015
	tan	1.6643	1.6709	1.6775	1.6842	1.6909	1.6977	1.7045	1.7113	1.7182	1.7251
Degs.	Function	0'	6'	12'	18'	24'	30'	36'	42'	48'	54'

Natural Sines, Cosines, and Tangents—(Continued)

60°-74.9°

Degs.	Function	0.0°	0.1°	0.2°	0.3°	0.4°	0.5°	0.6°	0.7°	0.8°	0.9°
60	sin	0.8660	0.8669	0.8678	0.8686	0.8695	0.8704	0.8712	0.8721	0.8729	0.8738
	cos	0.5000	0.4985	0.4970	0.4955	0.4939	0.4924	0.4909	0.4894	0.4879	0.4863
	tan	1.7321	1.7391	1.7461	1.7532	1.7603	1.7675	1.7747	1.7820	1.7893	1.7966
61	sin	0.8746	0.8755	0.8763	0.8771	0.8780	0.8788	0.8796	0.8805	0.8813	0.8821
	cos	0.4848	0.4833	0.4818	0.4802	0.4787	0.4772	0.4756	0.4741	0.4726	0.4710
	tan	1.8040	1.8115	1.8190	1.8265	1.8341	1.8418	1.8495	1.8572	1.8650	1.8728
62	sin	0.8829	0.8838	0.8846	0.8854	0.8862	0.8870	0.8878	0.8886	0.8894	0.8902
	cos	0.4695	0.4679	0.4664	0.4648	0.4633	0.4617	0.4602	0.4586	0.4571	0.4555
	tan	1.8807	1.8887	1.8967	1.9047	1.9128	1.9210	1.9292	1.9375	1.9458	1.9542
63	sin	0.8910	0.8918	0.8926	0.8934	0.8942	0.8949	0.8957	0.8965	0.8973	0.8980
	cos	0.4540	0.4524	0.4509	0.4493	0.4478	0.4462	0.4446	0.4431	0.4415	0.4399
	tan	1.9626	1.9711	1.9797	1.9883	1.9970	2.0057	2.0145	2.0233	2.0323	2.0413
64	sin	0.8988	0.8996	0.9003	0.9011	0.9018	0.9026	0.9033	0.9041	0.9048	0.9056
	cos	0.4384	0.4368	0.4352	0.4337	0.4321	0.4305	0.4289	0.4274	0.4258	0.4242
	tan	2.0503	2.0594	2.0686	2.0778	2.0872	2.0965	2.1060	2.1155	2.1251	2.1348
65	sin	0.9063	0.9070	0.9078	0.9085	0.9092	0.9100	0.9107	0.9114	0.9121	0.9128
	cos	0.4226	0.4210	0.4195	0.4179	0.4163	0.4147	0.4131	0.4115	0.4099	0.4083
	tan	2.1445	2.1543	2.1642	2.1742	2.1842	2.1943	2.2045	2.2148	2.2251	2.2355
66	sin	0.9135	0.9143	0.9150	0.9157	0.9164	0.9171	0.9178	0.9184	0.9191	0.9198
	cos	0.4067	0.4051	0.4035	0.4019	0.4003	0.3987	0.3971	0.3955	0.3939	0.3923
	tan	2.2460	2.2566	2.2673	2.2781	2.2889	2.2998	2.3109	2.3220	2.3332	2.3445
67	sin	0.9205	0.9212	0.9219	0.9225	0.9232	0.9239	0.9245	0.9252	0.9259	0.9265
	cos	0.3907	0.3891	0.3875	0.3859	0.3843	0.3827	0.3811	0.3795	0.3778	0.3762
	tan	2.3559	2.3673	2.3789	2.3906	2.4023	2.4142	2.4262	2.4383	2.4504	2.4627
68	sin	0.9272	0.9278	0.9285	0.9291	0.9298	0.9304	0.9311	0.9317	0.9323	0.9330
	cos	0.3746	0.3730	0.3714	0.3697	0.3681	0.3665	0.3649	0.3633	0.3616	0.3600
	tan	2.4751	2.4876	2.5002	2.5129	2.5257	2.5386	2.5517	2.5649	2.5782	2.5916
69	sin	0.9336	0.9342	0.9348	0.9354	0.9361	0.9367	0.9373	0.9379	0.9385	0.9391
	cos	0.3584	0.3567	0.3551	0.3535	0.3518	0.3502	0.3486	0.3469	0.3453	0.3437
	tan	2.6051	2.6187	2.6325	2.6464	2.6605	2.6746	2.6889	2.7034	2.7179	2.7326
70	sin	0.9397	0.9403	0.9409	0.9415	0.9421	0.9426	0.9432	0.9438	0.9444	0.9449
	cos	0.3420	0.3404	0.3387	0.3371	0.3355	0.3338	0.3322	0.3306	0.3289	0.3272
	tan	2.7475	2.7625	2.7776	2.7929	2.8083	2.8239	2.8397	2.8556	2.8716	2.8878
71	sin	0.9455	0.9461	0.9466	0.9472	0.9478	0.9483	0.9489	0.9494	0.9500	0.9505
	cos	0.3256	0.3239	0.3223	0.3206	0.3190	0.3173	0.3156	0.3140	0.3123	0.3107
	tan	2.9042	2.9208	2.9375	2.9544	2.9714	2.9887	3.0061	3.0237	3.0415	3.0595
72	sin	0.9511	0.9516	0.9521	0.9527	0.9532	0.9537	0.9542	0.9548	0.9553	0.9558
	cos	0.3090	0.3074	0.3057	0.3040	0.3024	0.3007	0.2990	0.2974	0.2957	0.2940
	tan	3.0777	3.0961	3.1146	3.1334	3.1524	3.1716	3.1910	3.2106	3.2305	3.2506
73	sin	0.9563	0.9568	0.9573	0.9578	0.9583	0.9588	0.9593	0.9598	0.9603	0.9608
	cos	0.2924	0.2907	0.2890	0.2874	0.2857	0.2840	0.2823	0.2807	0.2790	0.2773
	tan	3.2709	3.2914	3.3122	3.3332	3.3544	3.3759	3.3977	3.4197	3.4420	3.4646
74	sin	0.9613	0.9617	0.9622	0.9627	0.9632	0.9636	0.9641	0.9646	0.9650	0.9655
	cos	0.2756	0.2740	0.2723	0.2706	0.2689	0.2672	0.2656	0.2639	0.2622	0.2605
	tan	3.4874	3.5105	3.5339	3.5576	3.5816	3.6059	3.6305	3.6554	3.6806	3.7062
Degs.	Function	0'	6'	12'	18'	24'	30'	36'	42'	48'	54'

Natural Sines, Cosines, and Tangents—(Continued)

75°-89.9°

Degs.	Function	0.0°	0.1°	0.2°	0.3°	0.4°	0.5°	0.6°	0.7°	0.8°	0.9°
75	sin	0.9659	0.9664	0.9668	0.9673	0.9677	0.9681	0.9686	0.9690	0.9594	0.9699
	cos	0.2588	0.2571	0.2554	0.2538	0.2521	0.2504	0.2487	0.2470	0.2453	0.2436
	tan	3.7321	3.7583	3.7848	3.8118	3.8391	3.8667	3.8947	3.9232	3.9520	3.9812
76	sin	0.9703	0.9707	0.9711	0.9715	0.9720	0.9724	0.9728	0.9732	0.9736	0.9740
	cos	0.2419	0.2402	0.2385	0.2368	0.2351	0.2334	0.2317	0.2300	0.2284	0.2267
	tan	4.0108	4.0408	4.0713	4.1022	4.1335	4.1653	4.1976	4.2303	4.2635	4.2972
77	sin	0.9744	0.9748	0.9751	0.9755	0.9759	0.9763	0.9767	0.9770	0.9774	0.9778
	cos	0.2250	0.2232	0.2215	0.2198	0.2181	0.2164	0.2147	0.2130	0.2113	0.2096
	tan	4.3315	4.3662	4.4015	4.4374	4.4737	4.5107	4.5483	4.5864	4.6252	4.6646
78	sin	0.9781	0.9785	0.9789	0.9792	0.9796	0.9799	0.9803	0.9806	0.9810	0.9813
	cos	0.2079	0.2062	0.2045	0.2028	0.2011	0.1994	0.1977	0.1959	0.1942	0.1925
	tan	4.7046	4.7453	4.7867	4.8288	4.8716	4.9152	4.9594	5.0045	5.0504	5.0970
79	sin	0.9816	0.9820	0.9823	0.9826	0.9829	0.9833	0.9836	0.9839	0.9842	0.9845
	cos	0.1908	0.1891	0.1874	0.1857	0.1840	0.1822	0.1805	0.1788	0.1771	0.1754
	tan	5.1446	5.1929	5.2422	5.2924	5.3435	5.3955	5.4486	5.5026	5.5578	5.6140
80	sin	0.9848	0.9851	0.9854	0.9857	0.9860	0.9863	0.9866	0.9869	0.9871	0.9874
	cos	0.1736	0.1719	0.1702	0.1685	0.1668	0.1650	0.1633	0.1616	0.1599	0.1582
	tan	5.6713	5.7297	5.7894	5.8502	5.9124	5.9758	6.0405	6.1066	6.1742	6.2432
81	sin	0.9877	0.9880	0.9882	0.9885	0.9888	0.9890	0.9893	0.9895	0.9898	0.9900
	cos	0.1564	0.1547	0.1530	0.1513	0.1495	0.1478	0.1461	0.1444	0.1426	0.1409
	tan	6.3138	6.3859	6.4596	6.5350	6.6122	6.6912	6.7720	6.8548	6.9395	7.0264
82	sin	0.9903	0.9905	0.9907	0.9910	0.9912	0.9914	0.9917	0.9919	0.9921	0.9923
	cos	0.1392	0.1374	0.1357	0.1340	0.1323	0.1305	0.1288	0.1271	0.1253	0.1236
	tan	7.1154	7.2066	7.3002	7.3962	7.4947	7.5958	7.6996	7.8062	7.9158	8.0285
83	sin	0.9925	0.9928	0.9930	0.9932	0.9934	0.9936	0.9938	0.9940	0.9942	0.9943
	cos	0.1219	0.1201	0.1184	0.1167	0.1149	0.1132	0.1115	0.1097	0.1080	0.1063
	tan	8.1443	8.2636	8.3863	8.5126	8.6427	8.7769	8.9152	9.0579	9.2052	9.3572
84	sin	0.9945	0.9947	0.9949	0.9951	0.9952	0.9954	0.9956	0.9957	0.9959	0.9960
	cos	0.1045	0.1028	0.1011	0.0993	0.0976	0.0958	0.0941	0.0924	0.0906	0.0889
	tan	9.5144	9.6768	9.8448	10.02	10.20	10.39	10.58	10.78	10.99	11.20
85	sin	0.9962	0.9963	0.9965	0.9966	0.9968	0.9969	0.9971	0.9972	0.9973	0.9974
	cos	0.0872	0.0854	0.0837	0.0819	0.0802	0.0785	0.0767	0.0750	0.0732	0.0715
	tan	11.43	11.66	11.91	12.16	12.43	12.71	13.00	13.30	13.62	13.95
86	sin	0.9976	0.9977	0.9978	0.9979	0.9980	0.9981	0.9982	0.9983	0.9984	0.9985
	cos	0.0698	0.0680	0.0663	0.0645	0.0628	0.0610	0.0593	0.0576	0.0558	0.0541
	tan	14.30	14.67	15.06	15.46	15.89	16.35	16.83	17.34	17.89	18.46
87	sin	0.9986	0.9987	0.9988	0.9989	0.9990	0.9990	0.9991	0.9992	0.9993	0.9993
	cos	0.0523	0.0506	0.0488	0.0471	0.0454	0.0436	0.0419	0.0401	0.0384	0.0366
	tan	19.08	19.74	20.45	21.20	22.02	22.90	23.86	24.90	26.03	27.27
88	sin	0.9994	0.9995	0.9995	0.9996	0.9996	0.9997	0.9997	0.9997	0.9998	0.9998
	cos	0.0349	0.0332	0.0314	0.0297	0.0279	0.0262	0.0244	0.0227	0.0209	0.0192
	tan	28.64	30.14	31.82	33.69	35.80	38.19	40.92	44.07	47.74	52.08
89	sin	0.9998	0.9999	0.9999	0.9999	0.9999	1.000	1.000	1.000	1.000	1.000
	cos	0.0175	0.0157	0.0140	0.0122	0.0105	0.0087	0.0070	0.0052	0.0035	0.0017
	tan	57.29	63.66	71.62	81.85	95.49	114.6	143.2	191.0	286.5	573.0
Degs.	Function	0'	6'	12'	18'	24'	30'	36'	42'	48'	54'



# INDEX

Abbreviations . . . . .	55	Minimum Loss Pads . . . . .	10
Admittance . . . . .	17	Mutual Inductance . . . . .	13
Algebraic Formulas . . . . .	5	Ohm's Law . . . . .	24-25
Algebraic Symbols . . . . .	4	Open-Air Transmission Lines . . . . .	20
Attenuator Networks . . . . .	7-9	Peak Current . . . . .	21
Average Current . . . . .	21	Peak Volts . . . . .	21
Average Volts . . . . .	21	Phase Angle . . . . .	24
Capacitance . . . . .	12, 20, 29-32, 47-50	Pilot Lamp Data . . . . .	38
Capacitors . . . . .	12, 47-50	Power Factor . . . . .	24
Coefficient of Coupling . . . . .	13	"Q" Factor . . . . .	14
Coils . . . . .	26, 28-29	Quadratic Equations . . . . .	5
Concentric Transmission Lines . . . . .	20	R-F Coils . . . . .	26, 28-29
Conductance . . . . .	17	R.M.S. Current . . . . .	21
Constants . . . . .	4, 12, 21	R.M.S. Volts . . . . .	21
Conversion Chart . . . . .	37	Radicals and Exponents . . . . .	5
Coulombs . . . . .	12	Radio Color Codes . . . . .	47-53
Coupled Inductance . . . . .	12	Reactance . . . . .	13, 29-32
Coupling Coefficient . . . . .	13	Resistance . . . . .	12, 22, 24-25
Decay of $E$ & $I$ in $LCR$ Circuits . . . . .	18-19	Resistor-Capacitor Color Codes . . . . .	47-50
Decibels . . . . .	5-6	Resistors . . . . .	47
Diagram Symbols . . . . .	54	Resonance . . . . .	13, 29-32
Dielectric Constants . . . . .	12	Schematic Symbols . . . . .	54
Exponents and Radicals . . . . .	5	Self-Inductance . . . . .	12
Fractional Inches . . . . .	4	Shunts . . . . .	22-23
Frequency . . . . .	13, 20, 29-32	Solution of a Quadratic . . . . .	5
Growth of $E$ & $I$ in $LCR$ Circuits . . . . .	18-19	Speaker Matching—70 Volt System . . . . .	11
Impedance . . . . .	14-16, 20	Steady State $I$ and $E$ . . . . .	19
Inches to Millimeters . . . . .	4	Susceptance . . . . .	17
Inductance . . . . .	12, 13, 26, 28-32	Symbols . . . . .	54-55
Interchangeable Batteries . . . . .	45-46	Transient $I$ and $E$ . . . . .	18-19
Interchangeable Tubes . . . . .	39-44	Transmission Lines . . . . .	20
Log Tables . . . . .	56-57	Trigonometric Formulas . . . . .	36
Logarithms—How to use . . . . .	33-35	Trigonometric Functions . . . . .	36
Mathematical Constants . . . . .	4	Trigonometric Tables . . . . .	58-63
Mathematical Symbols . . . . .	4	Vacuum Tube Constants . . . . .	21
Meter Formulas . . . . .	22-23	Vacuum Tube Formulas . . . . .	21
Metric Relationships . . . . .	37	Vacuum Tube Symbols . . . . .	21
Millimeters to Inches . . . . .	4	Vertical Antenna, Capacitance . . . . .	20
Mixers . . . . .	9	Wavelength . . . . .	13, 20
Multipliers . . . . .	22-23	Wire Tables . . . . .	26-27

**Consult Your ALLIED Catalog  
for Everything in Radio, Television and Industrial Electronics**